

200 MARCO SIMPLE

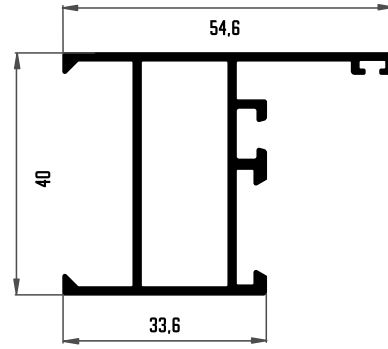

201 MARCO CON DREJAS

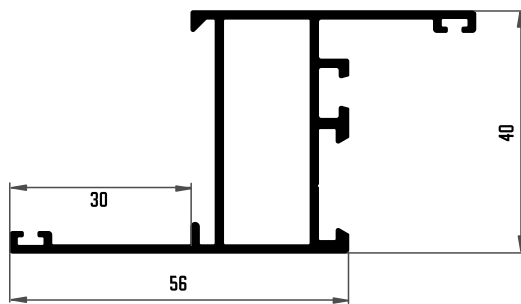

202 MARCO CON SOLAPE

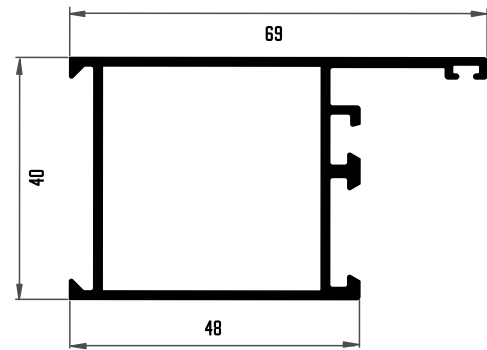

203 MARCO PORTADA

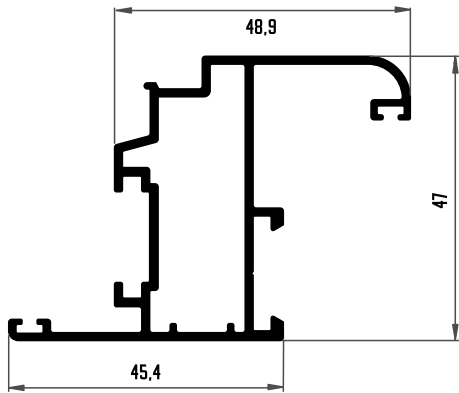

204 HOJA CURVA VENTANA

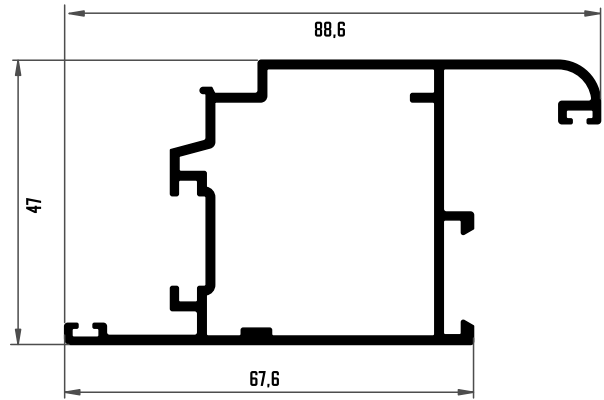

205 HOJA CURVA PORTADA

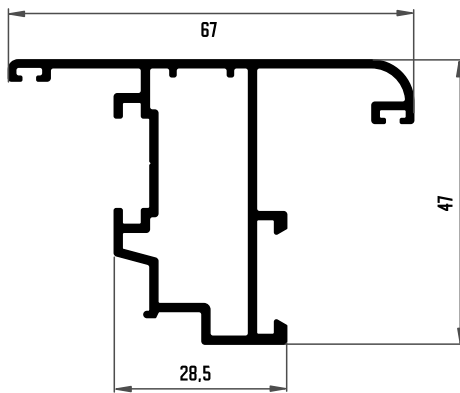

206 HOJA VENTANA APERTURA EXTERIOR

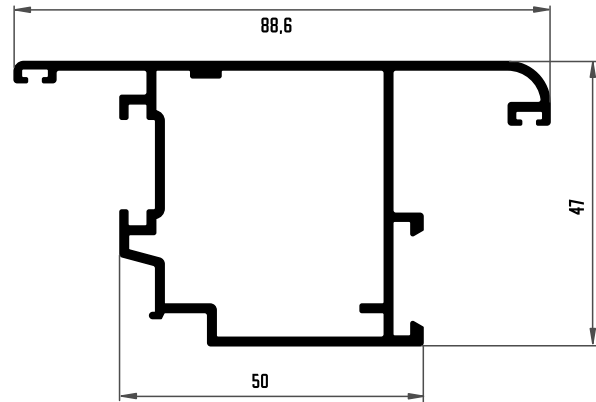

207 HOJA PORTADA APERTURA EXTERIOR

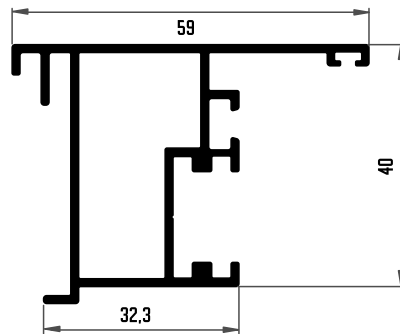

208 INVERSOR CENTRAL

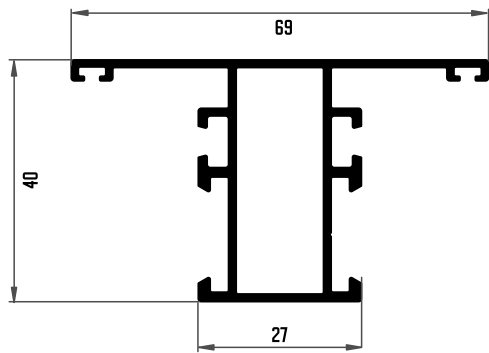

209 TRAVESAÑO VENTANA 69 MM

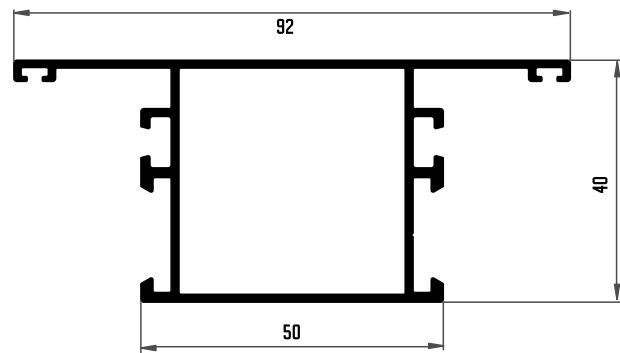

210 TRAVESAÑO PORTADA

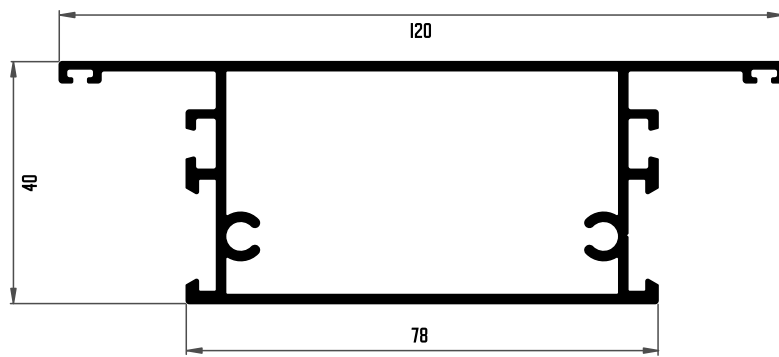

211 TRAVESAÑO DE ZÓCALO

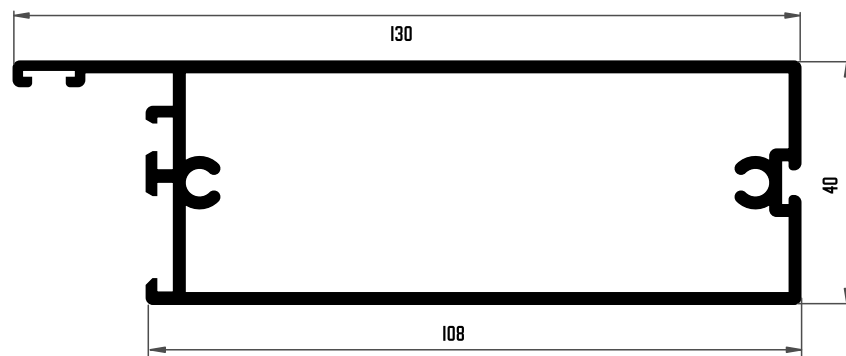

214 MARCO DE ZÓCALO

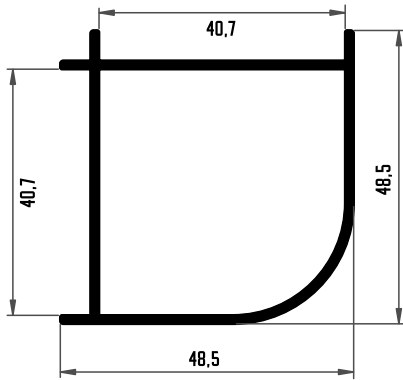

217 ESQUINERO 40 MM

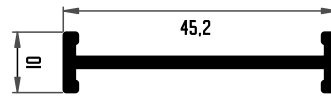

215 MAINEL CENTRAL 40 MM

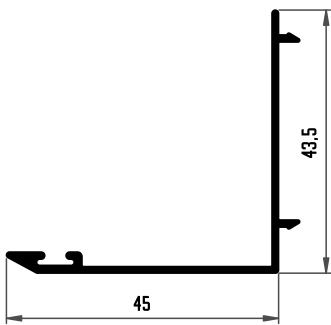

213 SOLAPE DE MARCO

* BAJO PEDIDO

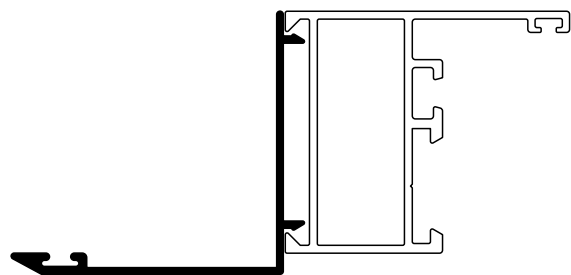

MONTAJE SOLAPE DE MARCO

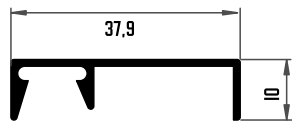

▶▶ 062 JAMBA LISA 37.9 MM ▶▶

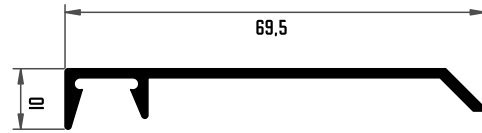

▶▶ 014 JAMBA LISA 69.5 MM ▶▶

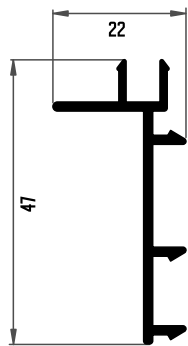

▶▶ 019 ACOPLA PARA JAMBA LISA ▶▶

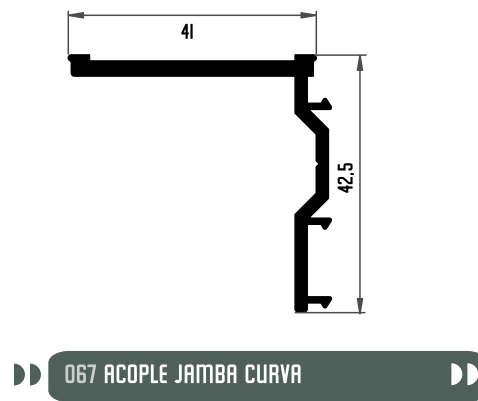

▶▶ 067 ACOPLA JAMBA CURVA ▶▶

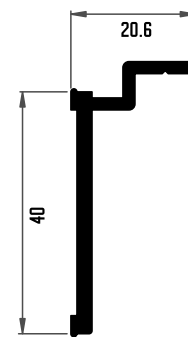

▶▶ 064 ACOPLA DE JAMBA ▶▶

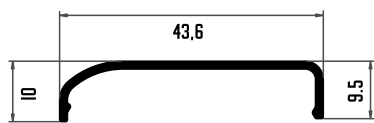

▶▶ 098 JAMBA CURVA 43 MM ▶▶

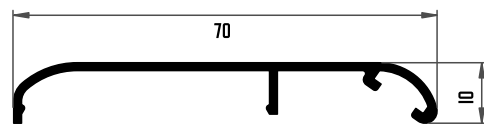

▶▶ 066 JAMBA CURVA 70 MM ▶▶

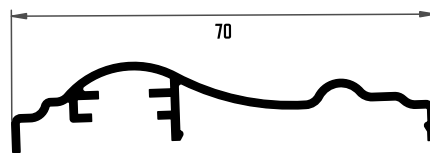

▶▶ 061 JAMBA DECORADA 70 MM ▶▶

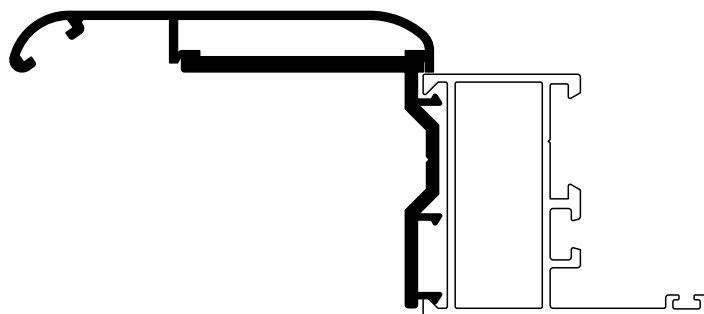



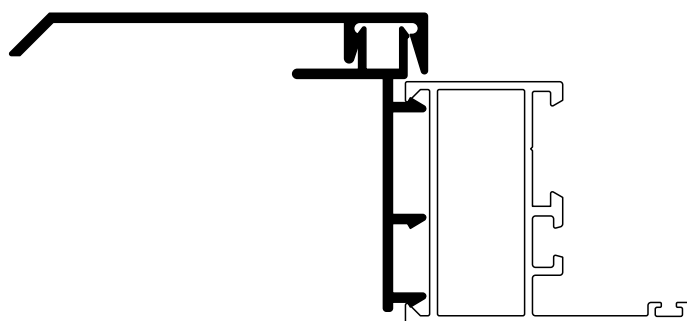



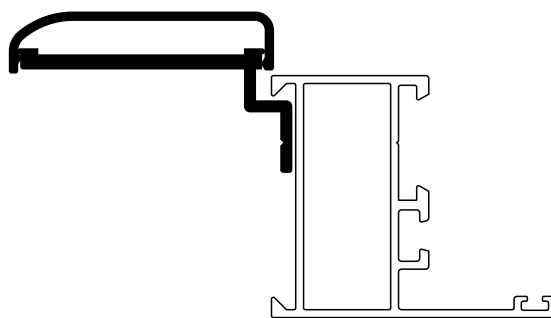



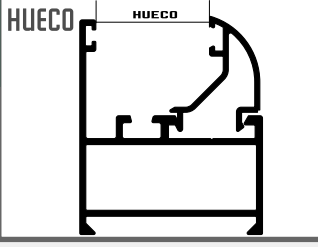



» MONTAJE JAMBA CURVA »



» MONTAJE JAMBA LISA »

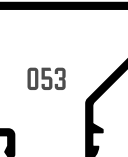

» MONTAJE JAMBA CURVA »

MEDIDA	TIPOS				
	RETESTAR	GAAPA	NUDO	LISO	
4 mm					32 mm
11 mm					25 mm
13 mm					23 mm
16 mm					20 mm
21 mm					15 mm
25 mm					11 mm
28 mm					8 mm
29 mm					7 mm
33.5 mm					2.5 mm

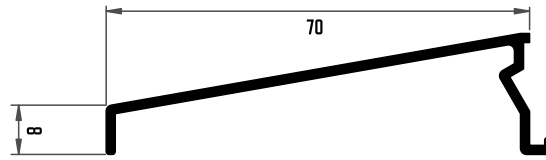

▶▶ 017 GOTERÓN 70 mm ▶▶

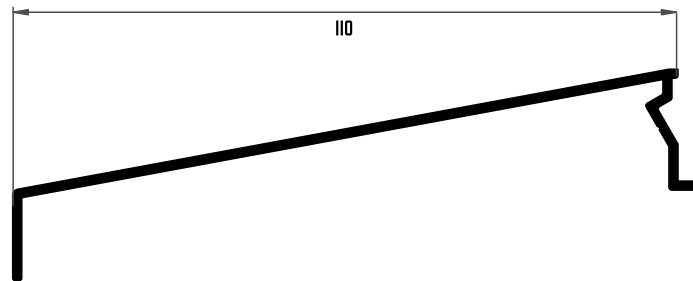

▶▶ 2770 GOTERÓN 110 mm ▶▶

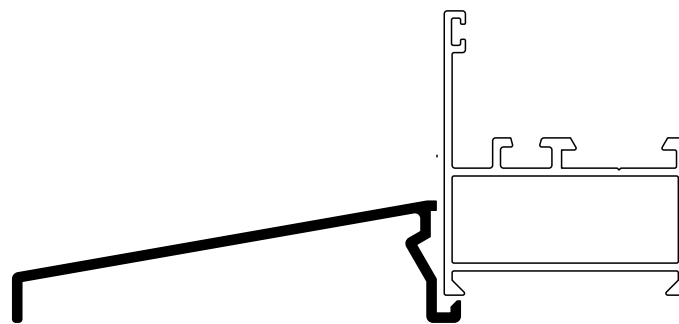

▶▶ MONTAJE GOTERÓN ▶▶

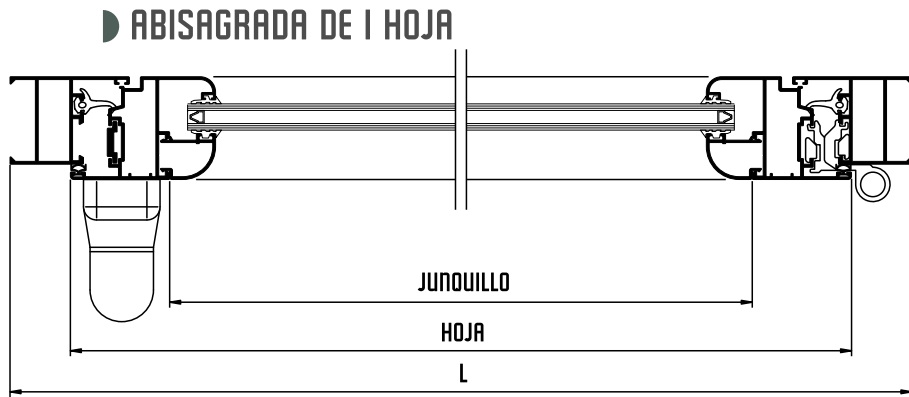

SECCIÓN A-A

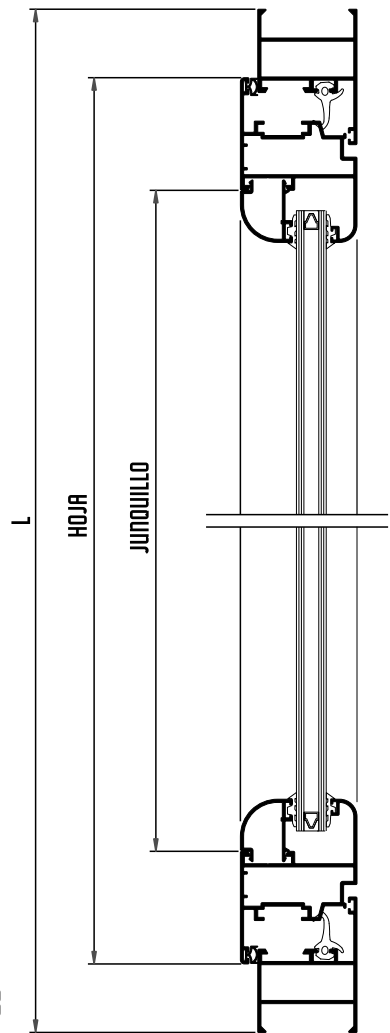
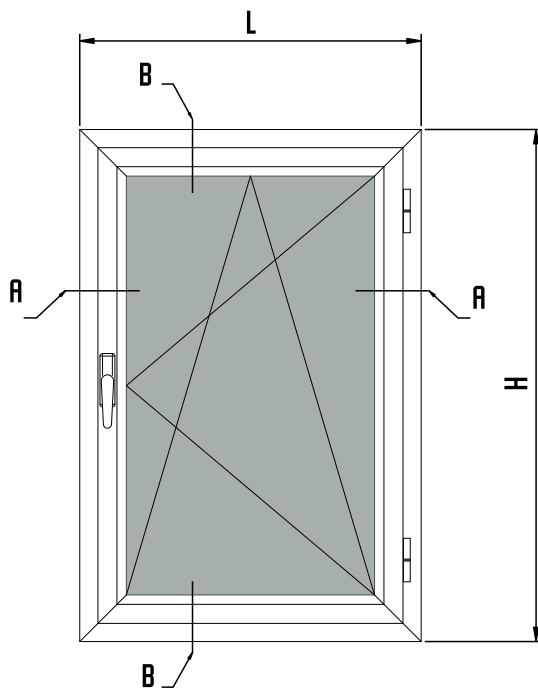

SECCIÓN B-B

CROQUIS	REFERENCIA	DENOMINACIÓN	TIPO DE CORTE	CANTIDAD	MEDIDA
	201	MARCO		2 2	L H
	204	HOJA CURVA		2 2	L-55.2 H-55.2
	030	JUNQUILLO REDONDO RETESTAR 21 MM		2 2	L-146 H-146

▶ ABISAGRADA DE 2 HOJAS

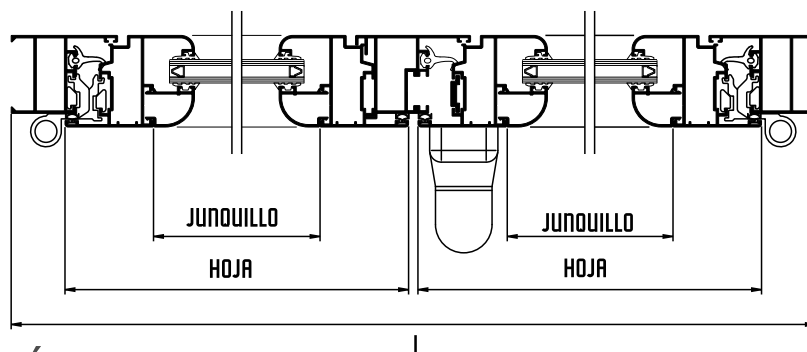



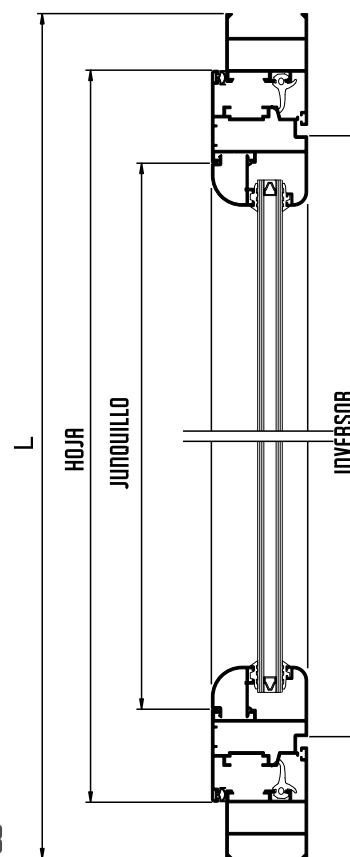
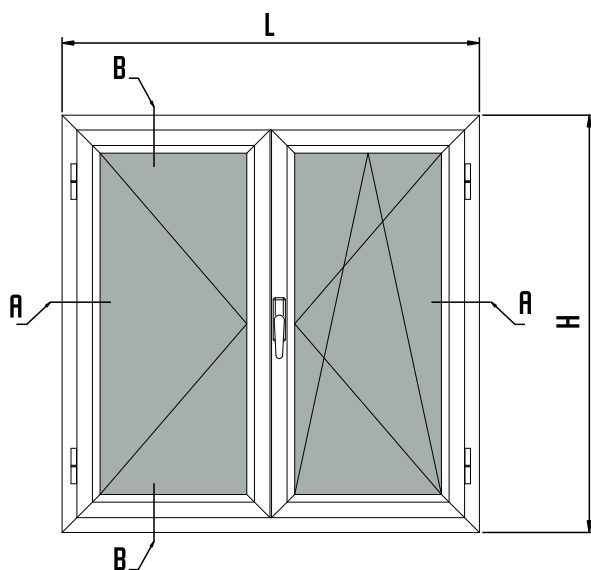









SECCIÓN A-A



SECCIÓN B-B

CROQUIS	REFERENCIA	DEMINACIÓN	TIPO DE CORTE	CANTIDAD	MEDIDA
	201	MARCO		2 2	L H
	204	HOJA CURVA		4 4	L/2-30 H-55.2
	208	INVERSOR		1	H-125.2
	030	JUNQUILLO REDONDO RETESTAR 21 mm		4 4	L/2-121 H-146

	CÓDIGO	DESCRIPCIÓN
	ANT8114 ANT8115	1418 TOPE RÁPIDO VENTANA SERIE A-40 3118 TOPE RÁPIDO PORTADA A-40
	ANE8116	12-3714-C ESCUADRA GRADUABLE A-40
	ANE8120	8-3714-150 ESCUADRA MARCO/HOJA SERIE A-40
	ANE8121	8-3736-150 ESCUADRA MARCO/HOJA PORTADA SERIE A-40
	ANE8563	4-3714 D ESCUADRAS INTERIOR PARA A-40
	ACE8168	ESCUADRA ALINEAMIENTO RPT A 4.3X 1 I PARA M. SOL Y A-40
	RC8064	JGO. TAPAS INVERSOR A-40 5202
	PPG8157	GOMA DE MARCO SERIE A-40 4090 150 MTS/ROLLO
	PPG8158	GOMA DE HOJA TUBULAR A-40 003-0004-040 MTS/ROLLO
	RSG8181	GOMA DE HOJA SERIE A-40 Y RPT PARA ESC. DE ALIMEAM. 321.055.C1 250 MTS/R
	RSG8186	GOMA EXTERIOR DE MARCO SERIE A-40 303.041 C1 250 MTS/R
	RSG8149	GOMA DE AJUNQUILLAR 328.057.C1 250 MTS/R
	RSG8132	ROLLO PLETINA DE PVC 815.196.R1 250MTS/R

TROQUEL PARA A-40

SERIE 2

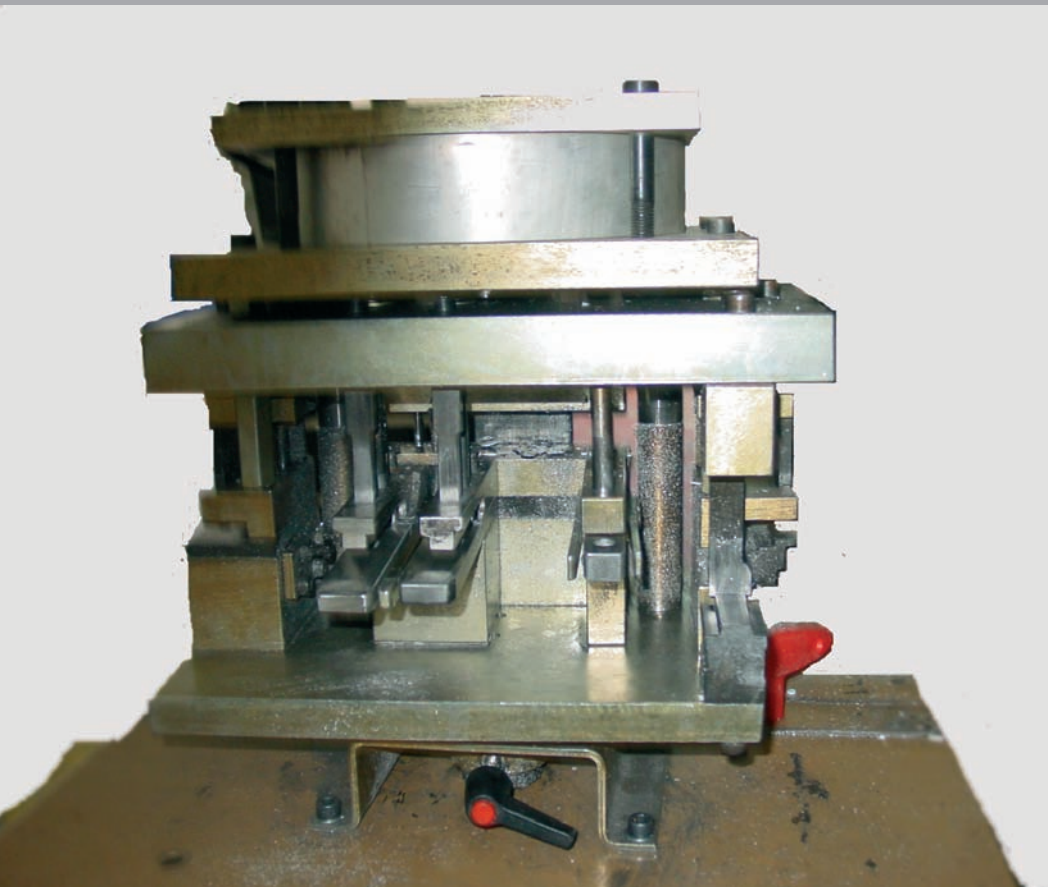

MECANIZADO DE :

- ESCUADRAS
- CREMONA
- PLETINA CREMONA
- SALIDA DE AGUAS
- TOPE TRAVESAÑO
- CONEXIÓN OSCILO