

CÓDIGO

DESCRIPCIÓN

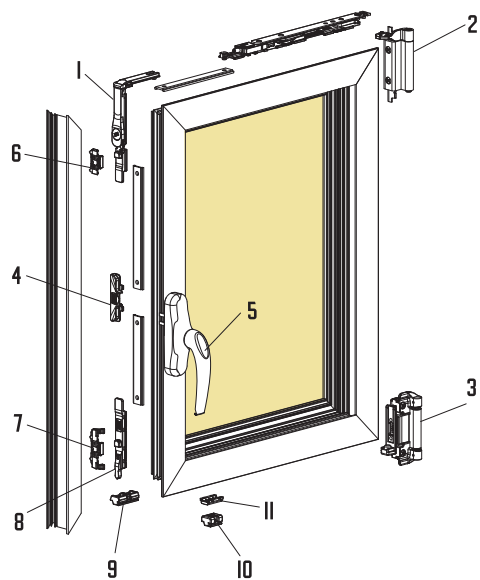

COMPONENTES KIT BASE OSCILOBATIENTE CIERRE AL INVERSOR

NUM.	DENOMINACIÓN	Nº ELEMENTOS
1	ÁNGULO DE REENVÍO	1
2	BISAGRA SUPERIOR DE OSCILO	1
3	BISAGRA INFERIOR DE OSCILO	1
4	FUNDA DE TRANSMISIÓN	1
5	CREMONA LYRA	1
6	PUNTO DE CIERRE REGULABLE	1
7	CERRADERO LATERAL DE OSCILO	1
8	TERMINAL HOJA ACTIVA	1
9	CERRADERO INFERIOR	1
10	RESBALÓN MARCO	1
11	RESBALÓN HOJA	1

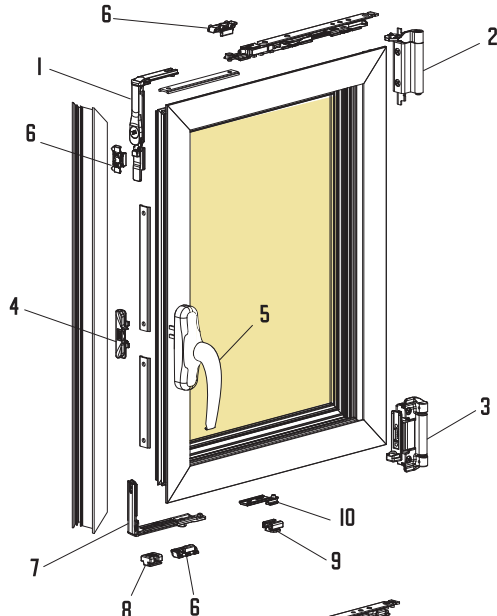





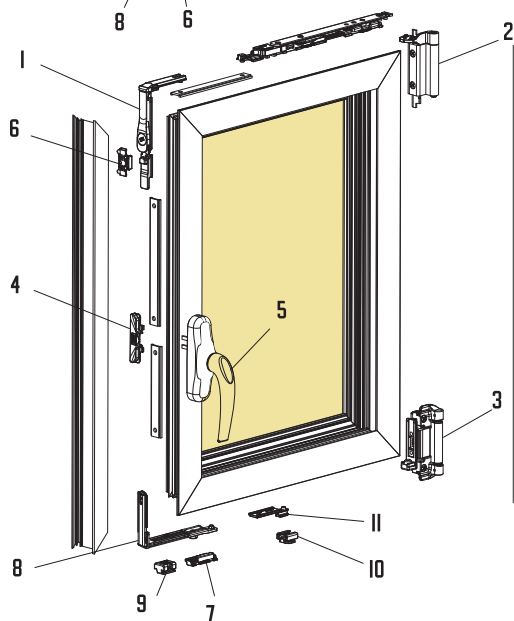









COMPONENTES KIT BASE OSCILOBATIENTE CIERRE AL MARCO

NUM.	DENOMINACIÓN	Nº ELEMENTOS
1	ÁNGULO DE REENVÍO	1
2	BISAGRA SUPERIOR DE OSCILO	1
3	BISAGRA INFERIOR DE OSCILO	1
4	FUNDA DE TRANSMISIÓN	1
5	CREMONA LYRA	1
6	PUNTO DE CIERRE REGULABLE	3
7	ÁNGULO DE REENVÍO HORIZONTAL	1
8	RESBALÓN MARCO	1
9	ANTIPALANCA MARCO	1
10	ANTIPALANCA HOJA	1













COMPONENTES KIT BASE OSCILOBATIENTE MANIOBRA LÓGICA

NUM.	DENOMINACIÓN	Nº ELEMENTOS
1	ÁNGULO DE REENVÍO	1
2	BISAGRA SUPERIOR DE OSCILO	1
3	BISAGRA INFERIOR DE OSCILO	1
4	FUNDA DE TRANSMISIÓN	1
5	CREMONA LYRA	1
6	PUNTO DE CIERRE REGULABLE	1
7	PUNTO DE CIERRE REGULABLE MANIOBRA LÓGICA	1
8	ÁNGULO DE REENVÍO HORIZONTAL	1
9	RESBALÓN MARCO	1
10	ANTIPALANCA MARCO	1
11	ANTIPALANCA HOJA	1

	CÓDIGO	DESCRIPCIÓN
	ST8611	MANILLA CENTRADA PRACTICABLE STAC (07100*)
	BI8001D	MANILLA DERECHA PRACTICABLE B-3400 MM BIPLAXT
	BI8088B	CONTRAFUERTE PARA CREMONA B-3400 BIPLAXT (B-715)
	BI8015D	MANILLA DERECHA B-3400 OSCILO BATIENTE BIPLAXT
	ST8610	JGO. MANILLA RECUPERABLE STAC (080*)
	ST8615	MANILLA CON LLAVE PRACTICABLE STAC
	ST8614	MANILLA CON LLAVE OSCILOBATIENTE STAC
	AS8005	MANILLA DESMONTABLE A.S.K. PARA CREMONA "EUROKEY"
	AS8006	CREMONA "EUROWAY" PRACTICABLE A.S.K.
	AS8018	CREMONA "EUROWAY" OSCILOBATIENTE A.S.K.
	LV8010 LV8515	CONJUNTO CREMONA MICRO APERT. EXT. LAVAAL (2 TORN+PROLONG) TORNILLO UNIÓN MICRO 23 MM APT EXT. LAVAAL
	BI8570	MANILLA PRESIÓN BIPLAXT CP/200
	PR8013	MANILLA ESTRECHA RECTA (PROCOMSA) 00139-00 PARA CERR. BASCULANTE
	PR8520	CERRADURA BASCULANTE (PROCOMSA) A-92420-00-0-0





	CÓDIGO	DESCRIPCIÓN
	ST8608D ST8608I	BISAGRA DCHA. STAC 012D PLETINA INOX. C/PRISIONERO BISAGRA IZODA. STAC 012I PLETINA INOX. C/PRISIONERO
	ST8609D ST8609I	BISAGRA PUERTA STAC DCHA. 011 BISAGRA PUERTA STAC IZODA. 011
	MD8033	PERNIO OCULTO MD (MACHO+HEMBRA) 482-00000
	MD8056	CERRADERO CLIPAR S. EUROPEA MD 300 012-0000E
	BI8054	JGO. PASADOR HOJA PASIVA B-707 PRACTICABLE
	LV8063	MECANISMO PASADOR NYLON
	BI8074	JGO. PASADOR HOJA PASIVA B-2013 O.B. C/CERRADEROS ZAMAK
	BI8087	JGO. PASADOR ZAMAK HOJA PASIVA B-8000 O.B. C/CERRADEROS
	ST8600	KIT 1 HOJA STAC
	ST8601	KIT 2 HOJAS STAC
	BI8055	CERRADERO SIMPLE 3014 (ENCUENTRO)
	BI8057	TAPA SALIDA DE AGUA CURVA
	BI8058	CLIP PARA JUNQUILLO PASSARINI C-101
	BI8059	NUDO MD-041



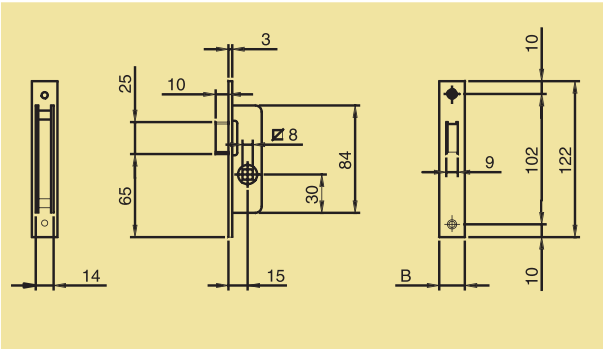

	CÓDIGO	DESCRIPCIÓN
	BI8073D BI80731	KIT O.B. DCHO. (HERR+MAN) BIPLAXT B-2000 KIT O.B. IZDO. (HERR+MAN) BIPLAXT B-2000
	BI8078	COMPÁS PEQUEÑO B-559 BIPLAXT
	BI8079	COMPÁS GRANDE B-558 BIPLAXT
	BI8084	B-2012 CIERRE EN ALTURA COMPÁS GRANDE BIPLAXT
	BI8086	B-2020 SUPLEMENTO CIERRE (MACHO-HEMERA) EN ALTURA BIPLAXT
	AC8081 AC8489	JGO. COMPÁS CON DESBLOQUEO EUROPEO 150 INOX. JGO. COMPÁS CON DESBLOQUEO EUROPEO 220 INOX
	AC8082	CIERRE DE VENTANAL BASCULANTE CANGREJOS
	ST8600	KIT OSCILO I HOJA III8* STAC
	ST8602 ST8603 ST8604	COMPÁS GRANDE OSCILO I10301 STAC COMPÁS PEQUEÑO OSCILO I10302 STAC COMPÁS MINI OSCILO I10303 STAC
	ST8605	CONJUNTO PASADORES PALANCA HOJA PASIVA OSCILO I11600 STAC
	ST8606	CONJUNTO BISAGRAS HOJA PASIVA OSCILO REGULABLES I114* STAC
	ST8607	ÁNGULO REENVIO SUPLEMENTARIO I12100 STAC
	BI8014I	TIRADOR SATURNO INDIVIDUAL
	BI8014J	TIRADOR SATURNO JUEGO

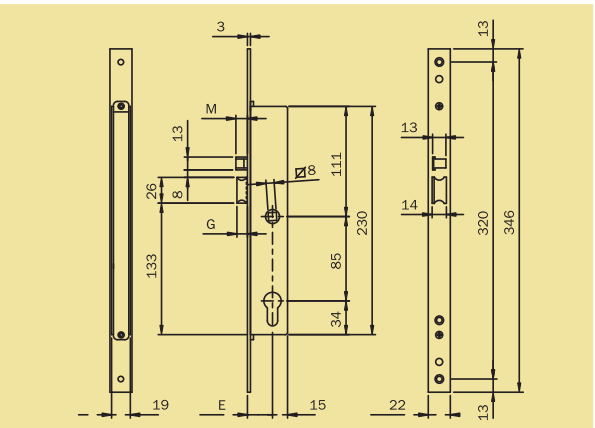
	CÓDIGO	DESCRIPCIÓN
	AM8450	PASADOR REF. 201 DE 150 MM
	AM8451	PASADOR REF. 201 DE 250 MM
	TS8588	CEPILLO PARA GUÍA SP 6.5X7 3P 225 MTS/ROLLO
	RSG8141	GOMA SUPERIOR MESA DE TRABAJO 912.316 P1 25 MTS/ROLLO
	RSG8142	GOMA INFERIOR MESA DE TRABAJO 932.370. P1 25 MTS/ROLLO
	RSG8187	GOMA DE ACRISTALAMIENTO N-10 100.110. P1 100 MTS/ROLLO
	RSG8155	GOMA DE ACRISTALAMIENTO N-12 114.120. P1 100 MTS/ROLLO
	RSG8144	GOMA DE ACRISTALAMIENTO N-22 114.220. P1 50 MTS/ROLLO
	RSG8145	GOMA DE ACRISTALAMIENTO N-14 114.140. P1 100 MTS/ROLLO
	RSG8146	GOMA DE ACRISTALAMIENTO N-16 114.160. P1 100 MTS/ROLLO
	BI8425	JGO. MANILLÓN VENUS 1 CURVO (315MM)
	BI8426	MANILLÓN VENUS 1 CURVO INDIVIDUAL (315MM)
	BI8431	JGO. MANILLÓN VENUS 4 (350MM)
	BI8432	MANILLÓN VENUS 4 (350MM) INDIVIDUAL

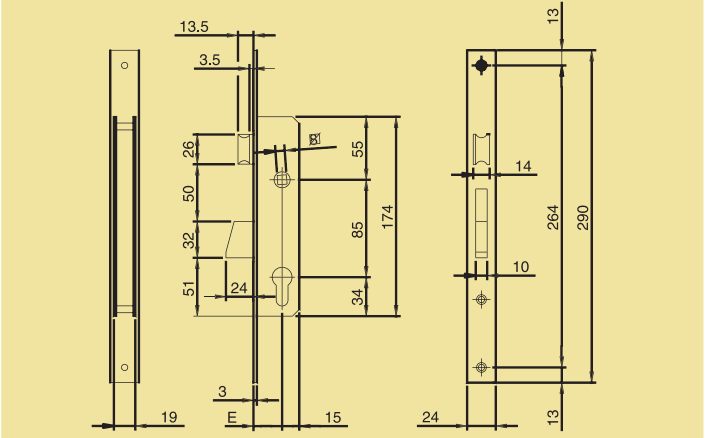
	CÓDIGO	DESCRIPCIÓN
	DM8419 DM8420	CIERRAPUERTAS TS 71 CON BRAZO RETENEDOR CIERRAPUERTAS TS 71 CON BRAZO NORMAL
	AM8440	TIRADOR BERNA DE 300 MM
	DC8540	ABREPUERTAS ELÉCTRICO (4IADF/PX) 22MM
	AS8083	JUEGO COMPÁS TELESCÓPICO LÁSER ACERO INOX ASK
	AM8247	JGO. BISAGRAS 2220 CON MUELLE DOBLE ACCIÓN VAIVÉN

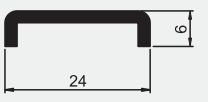
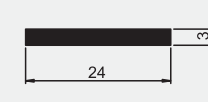
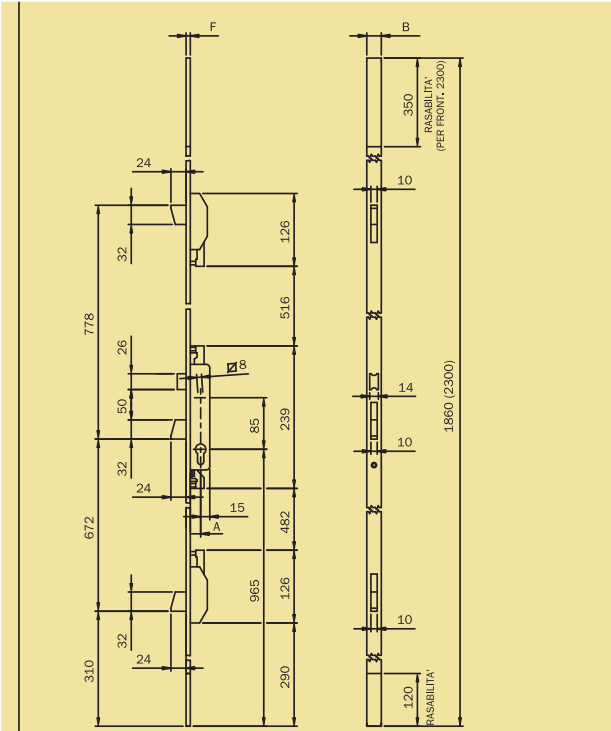
	CÓDIGO	DESCRIPCIÓN
	ER8461	TAPAS PARA TUBO 40X20
	ER8462	TAPAS PARA TUBO 40X40
	ER8464	TAPAS PARA TUBO 20X20
	ER8465	TAPAS PARA TUBO 30X30
	ER8466	TAPAS PARA TUBO 60X20
	ER8467	TAPAS PARA TUBO 30X15
	ER8468	TAPAS PARA TUBO 60X40
	SG8469	TAPAS PARA TUBO 70X20
	ER8479	TAPAS PARA TUBO 80X40
	ER8478	TAPAS PARA TUBO 100X40

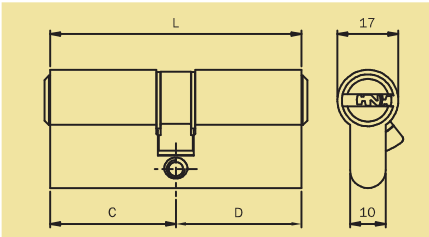
CERRADURAS	CÓDIGO	DESCRIPCIÓN
<p>SOLO RESBALÓN</p>  <p>TORNILLO DE REVERSIBILIDAD</p>	<p>IS8119</p>	<p>CERRADURA DE EMBUTIR PARA CARPINTERIAS DE ALUMINIO</p> 
CÓDIGO	CÓDIGO	DESCRIPCIÓN
<p>MANILLA SÓLO RESBALÓN AUTOBLOCANTE</p> 	<p>IS8413</p>	<p>ELECTRO CERRADURA 12V AC-DC DE EMBUTIR PARA CARPINTERIAS DE ALUMINIO. FRENTE INOX 22X3 MM.</p> 
CÓDIGO	CÓDIGO	DESCRIPCIÓN
	<p>IS8400</p>	<p>CERRADURA DE EMBUTIR PARA CARPINTERIAS DE ALUMINIO. FRENTE INOX 24X3 MM.</p> 

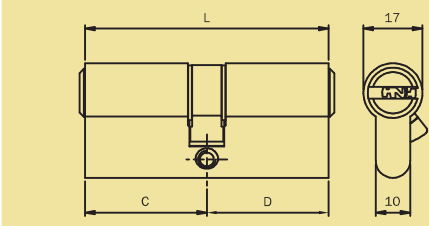
CÓDIGO	DESCRIPCIÓN
	<p>IS8405 IS8474</p> <p>CERRADURA MULTIPUNTO. FRENTE INOX 1.860 MM. FRENTE AJUSTABLE EN ALTURA INFERIOR, TRES PUNTOS DE CIERRE.</p> <div style="display: flex; justify-content: space-around;"> <div data-bbox="422 347 662 582"> <p>Rodilla y palanca</p>  </div> <div data-bbox="422 728 662 963"> <p>Resbalón y palanca</p>  </div> </div> 
CÓDIGO	DESCRIPCIÓN
	<p>IS8410 IS8412</p> <p>CILINDRO SEGURIDAD LATÓN 35X45 CILINDRO SEGURIDAD LATÓN 30X30</p> <p>Con barra anti-taladro. Se suministra con:</p> <ul style="list-style-type: none"> • 5 llaves • Tornillo de fijación 65 mm 
CÓDIGO	DESCRIPCIÓN
	<p>IS8406 IS8407</p> <p>CILINDRO 60 centrado 30x30 Leva Din 0° níquel. CILINDRO 70 30x40 Leva Din 30° níquel.</p> <p>Se suministra con:</p> <ul style="list-style-type: none"> • 3 llaves de tornillo de fijación 65 mm. 

HERRAJE OSCILO PARALELA PSK PORTAL LM PARA 1 HOJA

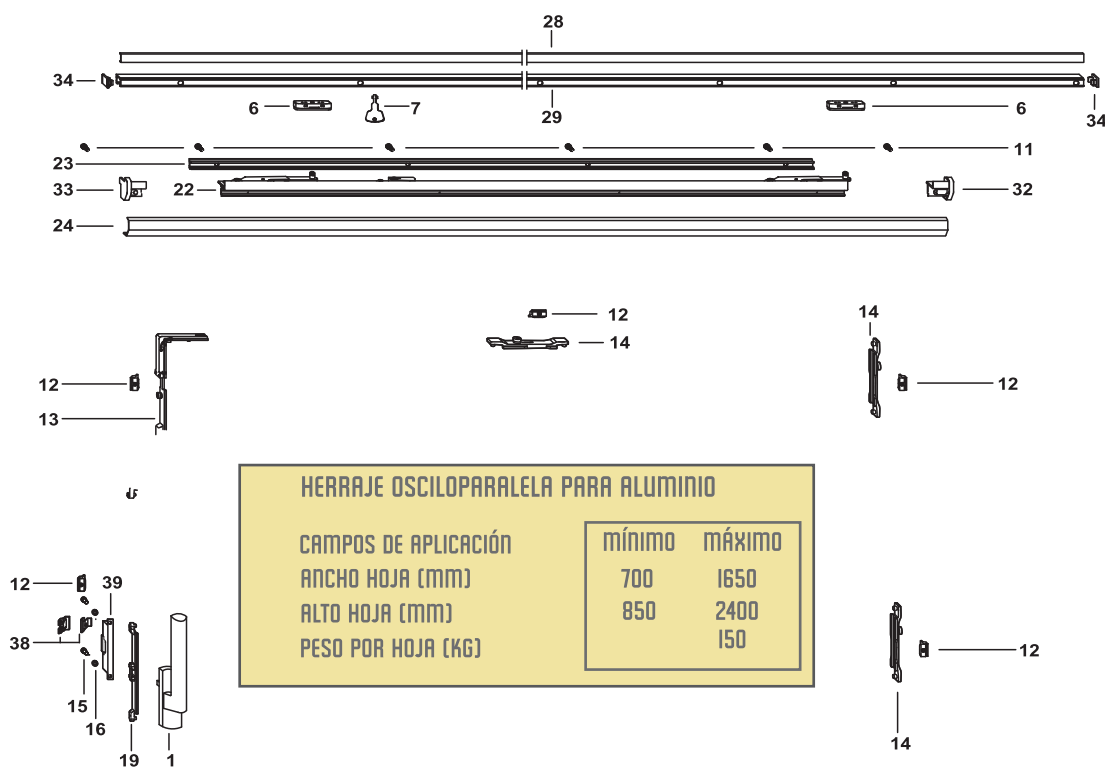

HERRAJE OSCILOPARALELA PARA ALUMINIO

CAMPOS DE APLICACIÓN	mínimo	máximo
ANCHO HOJA (MM)	700	1650
ALTO HOJA (MM)	850	2400
PESO POR HOJA (KG)		150

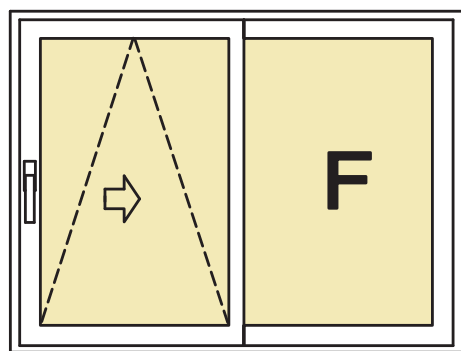

IZQUIERDA

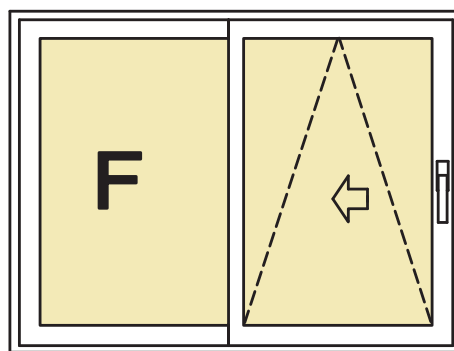

DERECHA

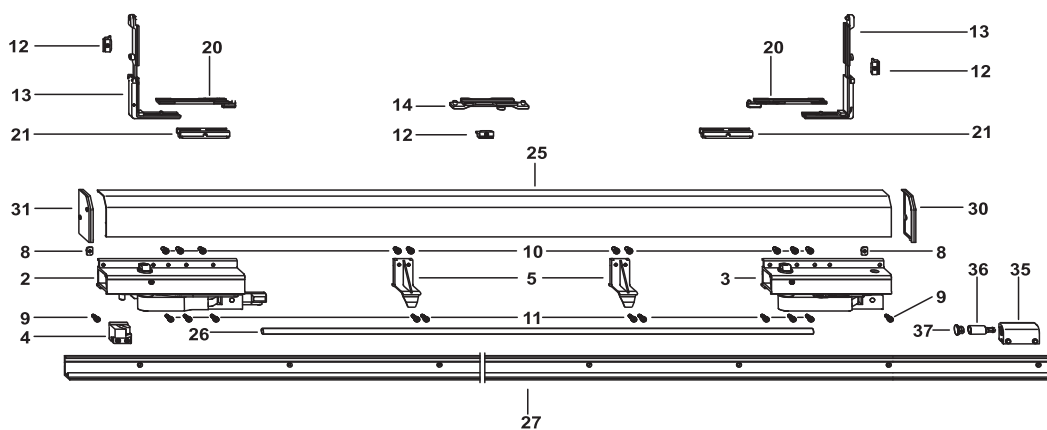

HERRAJE OSCILO PARALELA PSK PORTAL LM PARA 1 HOJA

NOMENCLATURA DE HERRAJES			
POSICIÓN	UNIDADES	DESCRIPCIÓN	CÓDIGO
1	1	Manilla PSK LM *NO SE PUEDE DESMONTAR	PLATA BLANCO NEGRO BRONCE SIN ANODIZAR
	1	CARTÓN BASE PSK LM	MANSIPSSKAP MANSIPSKABL MANSIPSKAB MANSIPSKAN MANSIPSKASA
2	1	CARRO DELANTERO	CPSKA CPSKDA
3	1	CARRO TRASERO	
4	1	TOPE IZQUIERDA/DERECHA	
5	2	SOPORTE TAPA INFERIOR HOJA	
6	2	DESIZALDOR	
7	1	LLAVE	
8	2	TUERCA PSK	
9	2	TORNILLO M5X5	
10	10	REMACHE ROSCADO	
11	10	TORNILLO M5X18	
	1	CONJUNTO CIERRES PSK	
12	1	CIERRE MV/N	
13	1	ÁNGULO DE REENVÍO TBT	
14	4	CIERRE INTERMEDIO	
15	2	TORNILLO M5X15	
16	2	CASQUILLOS	
19	1	PIEZA BASCULANTE	
20	2	CERRADERO BASCULANTE	
21	2	TORNILLO M5X5	
	1	GUÍA 87/200 ANCHO HOJA 700-900 mm ANCHO MARCO 2000 mm.	PLATA BLANCO BRONCE
	1	GUÍA 107/240 ANCHO HOJA 901-1100 mm ANCHO MARCO 2400 mm.	PLATA BLANCO BRONCE
	1	GUÍA 130/286 ANCHO HOJA 1101-1330 mm ANCHO MARCO 2860 mm.	PLATA BLANCO BRONCE
22	1	GUÍA160/346 ANCHO HOJA 1331-1650 mm ANCHO MARCO 3640 mm.	PLATA BLANCO BRONCE
23		COMPÁS PSK	
24		DISTANCIADOR COMPÁS (D160PSK) (D130PSK)	
25		TAPA SUPERIOR HOJA (TSPSKH573A/P/W/B)	
26		TAPA INFERIOR HOJA (TIPSKH573A/P/W/B)	
27		BARRA DE UNIÓN (BU130PSK) (BU160PSK)	
28		GUÍA INFERIOR MARCO	
29		TAPA SUPERIOR MARCO (TSPSKM573A/P/W/B)	
30		GUÍA SUPERIOR MARCO	
31		TAPA LATERAL INFERIOR HOJA DERECHA	
32		TAPA LATERAL INFERIOR HOJA IZQUIERDA	
33		TAPA LATERAL SUPERIOR HOJA DERECHA	(AGPSKLM/P/BL/B)
34		TAPA LATERAL SUPERIOR HOJA IZQUIERDA	
35		TAPA LATERAL SUPERIOR MARCO	
36		CAJA DE TOPE (TPSK)	
37		TOPE	
	1	TAPA	
	1	CONJUNTO FALSAMANIOBRA	FMNLMPSKA
	1	MANILLA INTERIOR 201 PZ	NEGRO HH170795
	1	MANILLA EXTERIOR 201 PZ PLANA	NEGRO HH170786
	1	MANILLA INTERIOR PSK LM CON LLAVE	BLANCO BRONCE NEGRO MANSIPSKLLABL MANSIPSKLLAB MANSIPSKLLAN
30 A 34		ACCESORIOS GUÍA PSK LM	PLATA BLANCO BRONCE AGPSKLM P AGPSKLM B L AGPSKLM B
22		COMPÁS PSK LM	DE 87 DE 107 DE 130 DE 160 COM87PSK COM107PSK COM130PSK COM160PSK

