

201 MARCO CON OREJAS

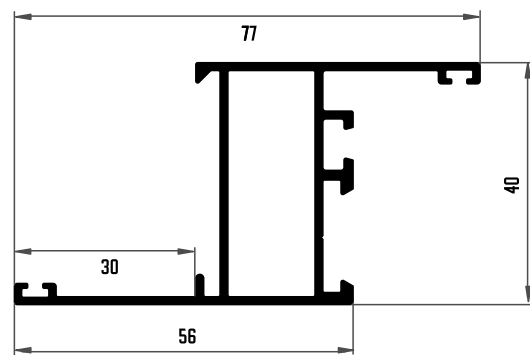

202 MARCO CON SOLAPE

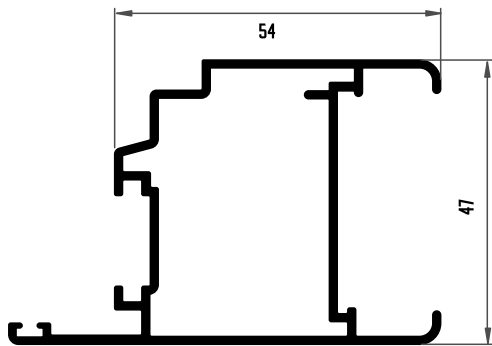

339 HOJA

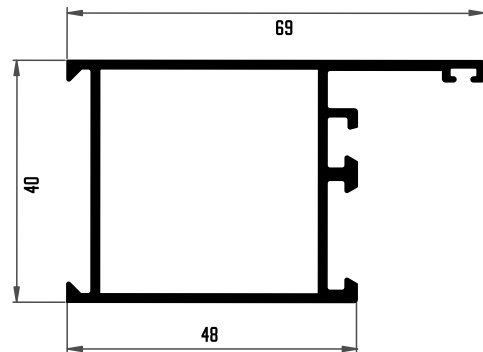

203 MARCO PORTADA

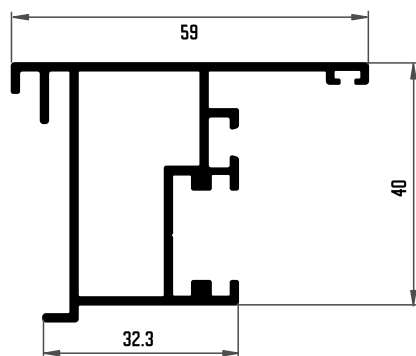

208 INVERSOR CENTRAL

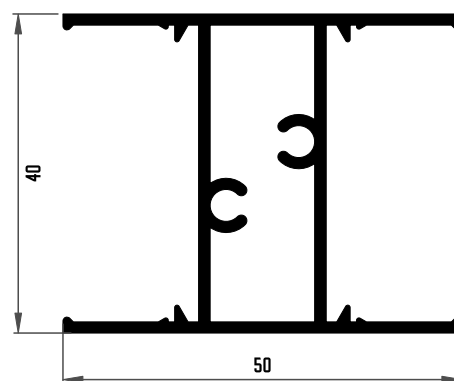

335 TRAVESAÑO CON GUSANILLO

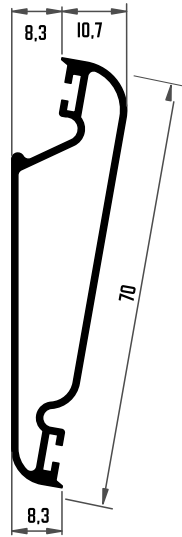

332 LAMA OVALADA FIJA

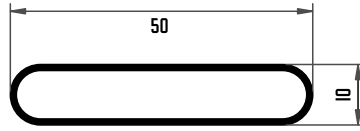

333 LAMA GRADUABLE

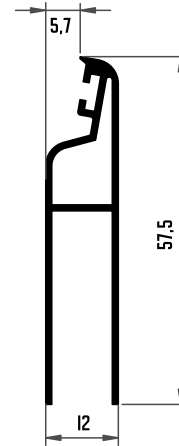

334 MEDIA LAMA GRADUABLE

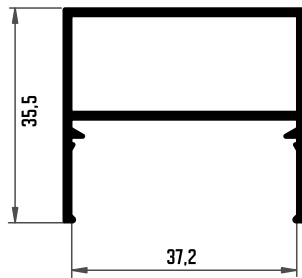

341 PERFIL MALLORQUINA

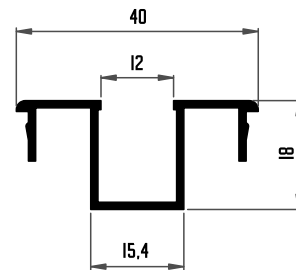

336 DIVISIÓN DE CRISTALES

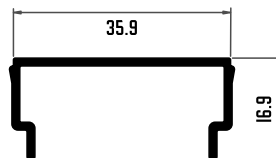

342 TAPA MECANISMO

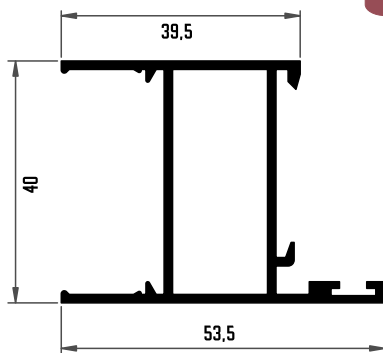

337 MARCO

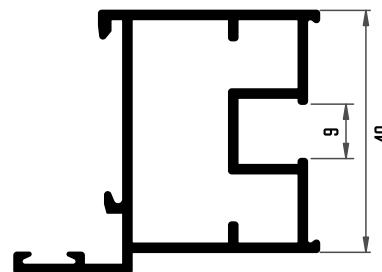

330 MARCO PARA LAMA FIJA

MONTAJE VENTANA I HOJA

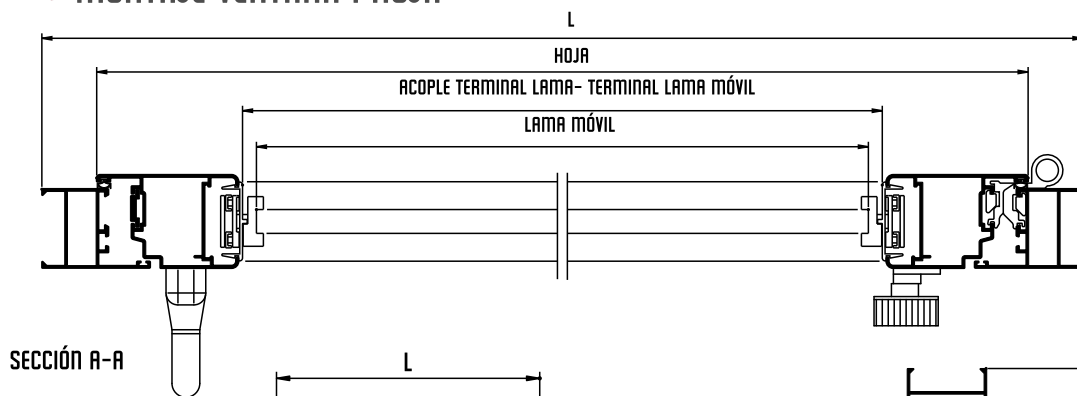

SECCIÓN A-A

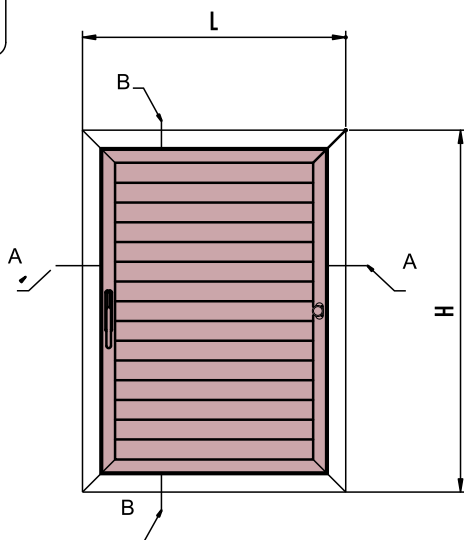

SECCIÓN B-B

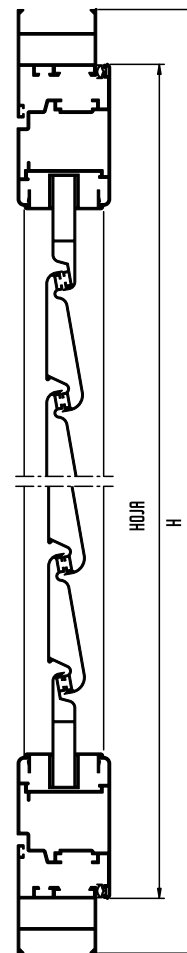

CROQUIS	REFERENCIA	DENOMINACIÓN	TIPO DE CORTE	CANTIDAD	MEDIDA
	201	MARCO		2 2	L H
	339	HOJA MALLORQUINA		2 2	L-55.2 H-55.2
	336	ACOPLE TERMINAL LAMA		2	L-202
	334	TERMINAL LAMA		2	L-202
	333	LAMA MÓVIL		***	L-216
	015	PLETINA CREMONA		1	H

Nº LAMAS	HOJA MDR. LUZ ALT./MAX.	Nº LAMAS	HOJA MDR. LUZ ALT./MAX.	Nº LAMAS	HOJA MDR. LUZ ALT./MAX.	Nº LAMAS	HOJA MDR. LUZ ALT./MAX.	Nº LAMAS	HOJA MDR. LUZ ALT./MAX.
3	282 mm	9	642 mm	15	1002 mm	21	1362 mm	27	1722 mm
4	342 mm	10	702 mm	16	1062 mm	22	1422 mm	28	1782 mm
5	402 mm	11	762 mm	17	1122 mm	23	1482 mm	29	1842 mm
6	462 mm	12	822 mm	18	1182 mm	24	1542 mm	30	1902 mm
7	522 mm	13	882 mm	19	1242 mm	25	1602 mm		
8	582 mm	14	942 mm	20	1302 mm	26	1662 mm		

▶ MONTAJE VENTANA 2 HOJAS

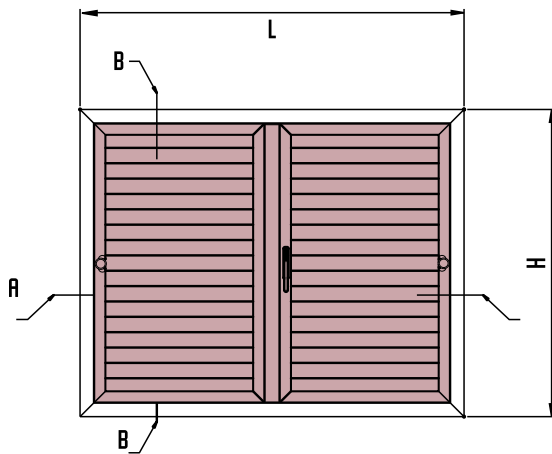
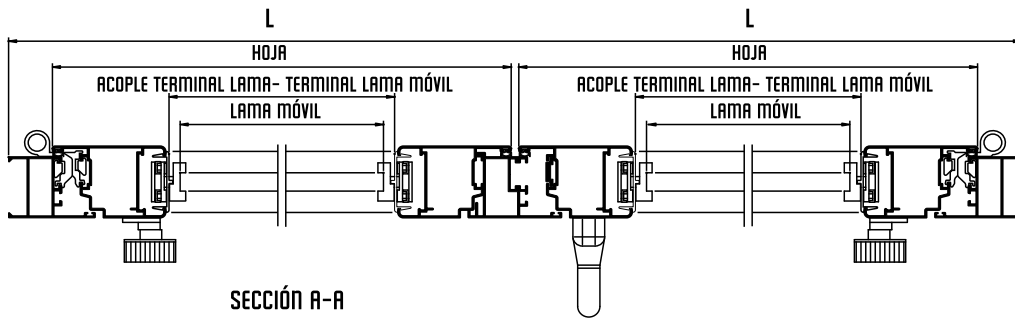

SECCIÓN B-B

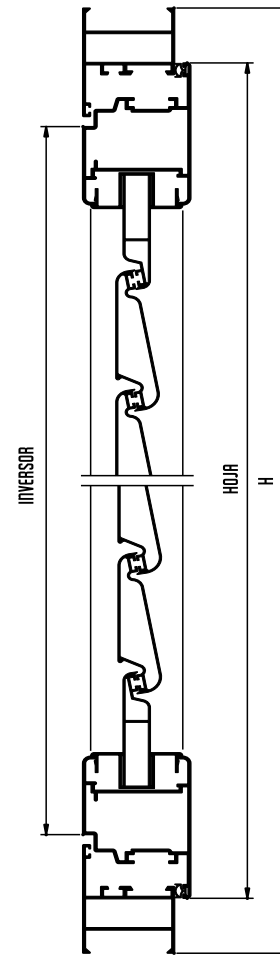

CROQUIS	REFERENCIA	DENOMINACIÓN	TIPO DE CORTE	CANTIDAD	MEDIDA
	201	MARCO		2 2	L H
	339	HOJA MALLORQUINA		2 2	L/2-30 H-55.2
	208	INVERSOR		1	L-119.2
	336	ACOPLE TERMINAL LAMA		4	L/2-176.8
	334	TERMINAL LAMA		4	L/2-176.8
	333	LAMA MÓVIL		***	L/2-190.8

Nº LAMAS	HOJA MDR. LUZ ALT./MAX.	Nº LAMAS	HOJA MDR. LUZ ALT./MAX.	Nº LAMAS	HOJA MDR. LUZ ALT./MAX.	Nº LAMAS	HOJA MDR. LUZ ALT./MAX.	Nº LAMAS	HOJA MDR. LUZ ALT./MAX.
3	282 mm	9	642 mm	15	1002 mm	21	1362 mm	27	1722 mm
4	342 mm	10	702 mm	16	1062 mm	22	1422 mm	28	1782 mm
5	402 mm	11	762 mm	17	1122 mm	23	1482 mm	29	1842 mm
6	462 mm	12	822 mm	18	1182 mm	24	1542 mm	30	1902 mm
7	522 mm	13	882 mm	19	1242 mm	25	1602 mm		
8	582 mm	14	942 mm	20	1302 mm	26	1662 mm		















	CÓDIGO	DESCRIPCIÓN
	RSG8252	GOMA PARA LAMA MALLORQUINA 331.050.CI 300 MTS/ROLLO
	TS8259	CEPILLO LAMA GRADUABLE "SP 5.5X6 3P" 325 MTS/ROLLO
	IT8275DI	JGO. TERMINAL 60 DCHA./IZDA. C/TORNILLO 09-008DX-SX
	DP8250D/I	TERMINAL M-23 DCHA./IZDA. DP (LAMA FIJA MALLORQUINA)
	DP8251 DP8445	SEPARADOR M-23/40 MM REVERSIBLE SEPARADOR M-23/50 MM REVERSIBLE
	DP8263	MINI GRILLO-SOPORTE FIJACIÓN A HOJA
	DP8257	GRILLO PARA 1 HOJA-SOPORTE FIJACIÓN A PARED
	DP8258	GRILLO "MIDI" PARA 2 HOJAS-SOPORTE FIJACIÓN A PARED 40MM
	DP8260D/I	SOPORTE DCHO./IZDO. ESTRECHO M-44 PARA 330 CELOSÍA
	DP8261D/I	SOPORTE DCHO./IZDO. CELOSÍA M-7 PARA 336
	DI8266D/I	830.007/8 BISAGRA 3ª HOJA DCHA./IZDA. 3 TORNILLOS B1010513T
	DI8267D/I	830.009/10 BISAGRA 4ª HOJA DCHA./IZDA. 3 TORNILLOS B1010413T
	DP8268D/I	DP-20I-N BISAGRA 4ª HOJA DCHA./IZDA. PALA LARGA
	LV8460D/I	CREMONA 4 HOJAS 1994 DCHA./IZDA. PR-8115 (946DX-SX)

TABLA TÉCNICA PARA MECANISMO PACO

CÓDIGO	DESCRIPCIÓN
DP8255	JGO.MECANISMO PACO GRADUABLE
DP8256	MANDO ROTARY IZODA/DARCHA



ALTURA MÍNIMA DE CORTE (MM)	ALTURA STANDARD	NÚMERO LAMAS	MANDO ROTARY A-MM
400	460	6	264
460	520	7	344
520	580	8	404
580	640	9	464
640	700	10	524
700	760	11	584
760	820	12	344/644
820	880	13	344/704
880	940	14	344
940	1000	15	344
1000	1060	16	344
1060	1120	17	344
1120	1180	18	344
1180	1240	19	344
1240	1300	20	344
1300	1360	21	344
1360	1420	22	344
1420	1480	23	344
1480	1540	24	344
1540	1600	25	344
1600	1660	26	344
1660	1720	27	344
1720	1780	28	344
1780	1840	29	344
1840	1900	30	344

MANDO ÚNICO

TABLA STANDARD

CÓDIGO	DESCRIPCIÓN	ALTURA	NÚMERO DE LAMAS
1T8269	MECANISMO MALLORQUINA G60	3150	51
1T8274	POMO TRANSMISIÓN ABS	3150	51

*SE SUMINISTRA A ESTA MEDIDA PARA CORTAR SEGÚN SE NECESITE

TROQUEL MALLORQUINA

SERIE 5



MECANIZADO DE:

- TAPA MALLORQUINA PARA LAMAS FIJAS (INCLINADA/RECTA)
- REFERENCIA 332