

# Catálogo rotura

Alumial expertos en perfilería de aluminio

**Corredera Lineal Elevable**

serie  
**Corredera Lineal  
Elevable**  
alumial 21/22

Corredera Lineal Elevable

# Catálogo carpintería

Alumial expertos en perfiles de aluminio

## Corredera Lineal Elevable

### Características técnicas

#### Ensayo AEV

Ventana 2 hojas

#### Permeabilidad del aire

UNE-EN 1026:2000

#### Estanqueidad del agua

UNE-EN 1027:2000

#### Resistencia a la carga del viento

UNE-EN 12211:2000

#### Ensayo AEV

Balconera de 2 hojas

#### Permeabilidad del aire

UNE-EN 1026:2000

#### Estanqueidad del agua

UNE-EN 1027:2000

#### Resistencia a la carga del viento

UNE-EN 12211:2000

CLASE 3

CLASE 7A

CLASE C5

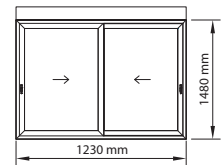

CLASE 3

CLASE 7A

CLASE C2

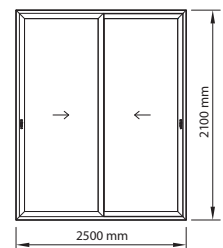

#### Ensayo térmico

#### Transmitancia térmica

UNE-EN ISO 12567-1:2002

Valores pertenecientes a ventana de 2 hojas de 1230\*1480 con acristalamiento 4/16/4

3,3 W/m2K (corredera- elevable)

3,5 W/m2K (corredera-deslizante)

#### Ensayo acústico

#### Aislamiento acústico RW

27 dB

UNE-EN ISO 140-3:1995

#### Tipologías y proporciones máximas recomendadas

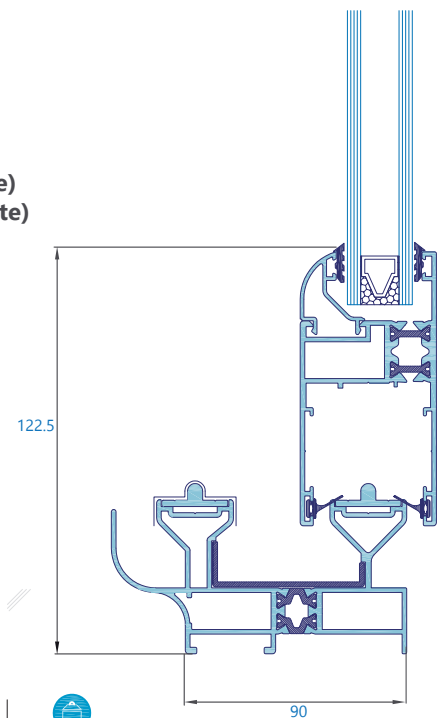
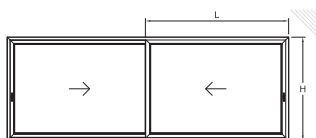

3300 mm



3200 mm



400 kg

Características máximas recomendadas para 1 hoja con herraje elevable y carro adicional. Consultar peso y dimensiones en el resto de las tipologías.

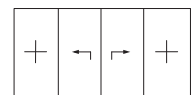
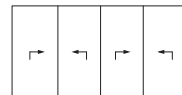
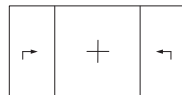
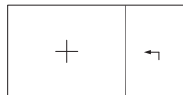
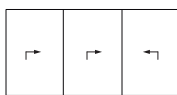
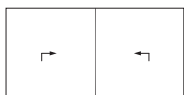

# Catálogo rotura

Alumial expertos en perfiles de aluminio

## Corredera Lineal Elevable

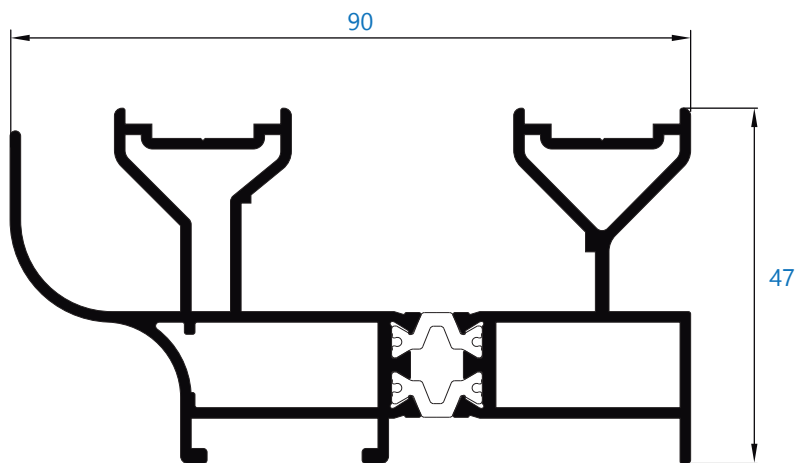

**R-170** marco

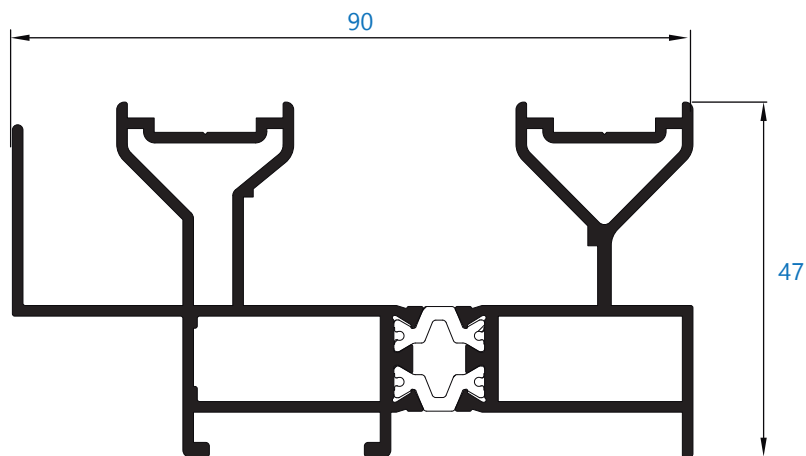

**R-172** marco ala recta elevable

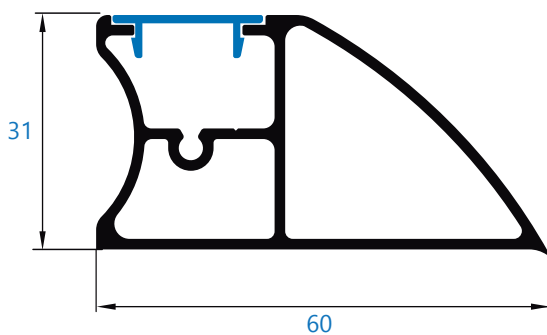

**4273-77** refuerzo+tapa  
\*perfil bajo pedido

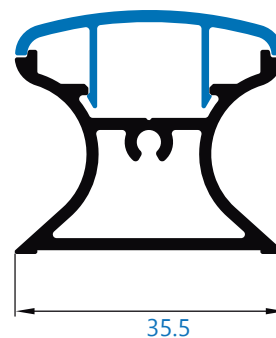

**11879-80** refuerzo+tapa tirador  
\*perfil bajo pedido

# Catálogo rotura

Alumial expertos en perfiles de aluminio  
**Corredera Lineal Elevable**

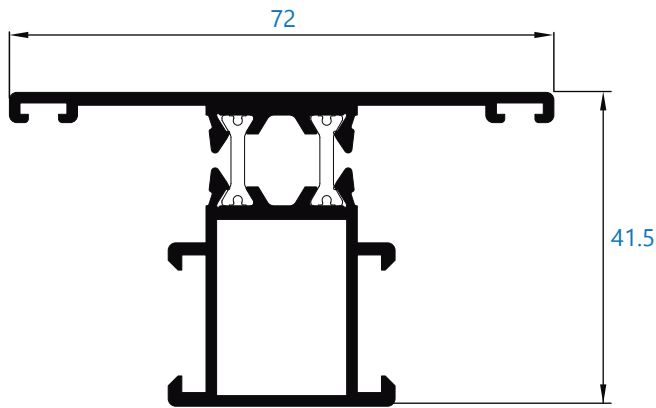

**R-173** travesaño de hoja

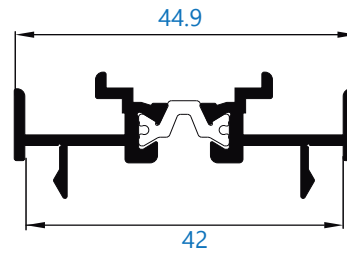

**R-135** unión de cuatro hojas



**4796** perfil guía

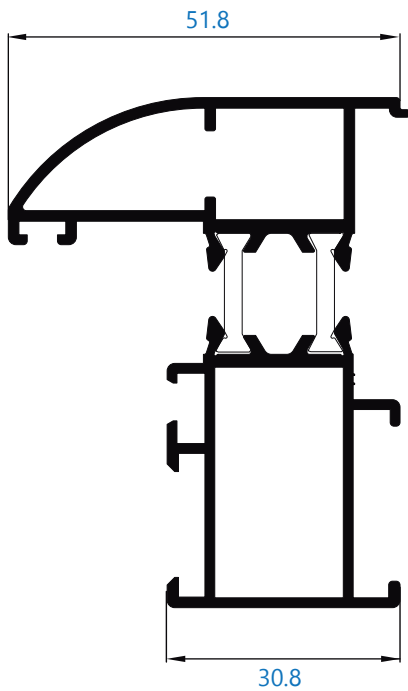

**R-174** paño fijo

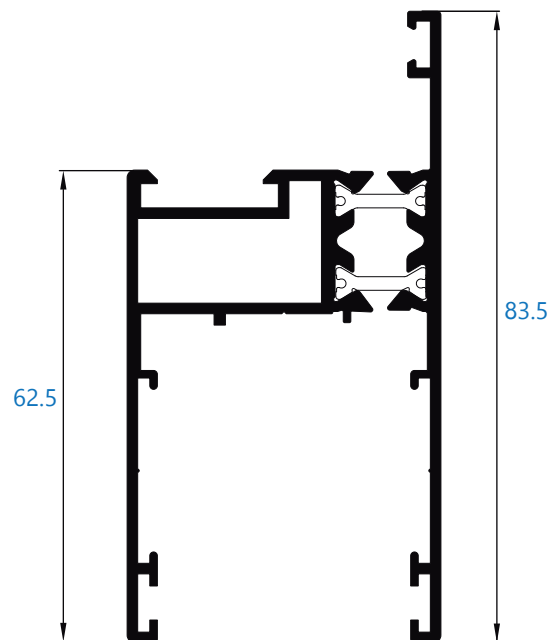

**R-171** hoja

**ALUMIAL**

Polígono Industrial Goardia, 2 20213 Idiazabal Gipuzkoa Tel.: 943 18 73 04 Fax: 943 18 73 83

# Catálogo rotura

Alumial expertos en perfiles de aluminio

**Corredera Lineal Elevable**

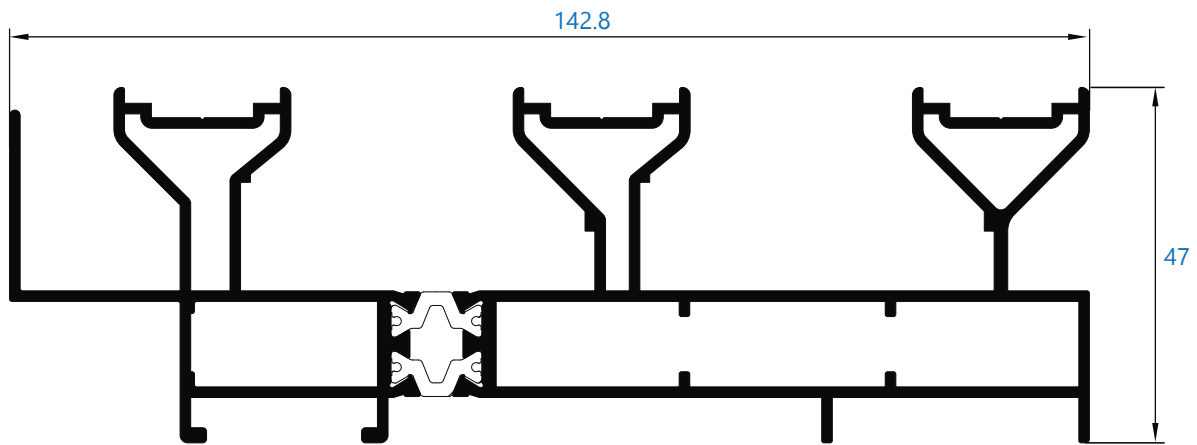

**R-132** marco recto 3 carriles

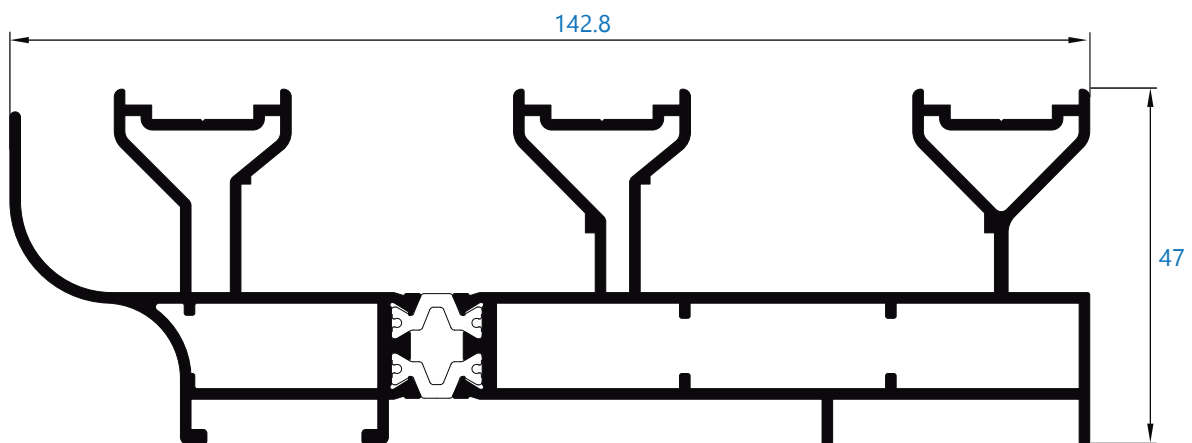

**R-134** marco 3 carriles

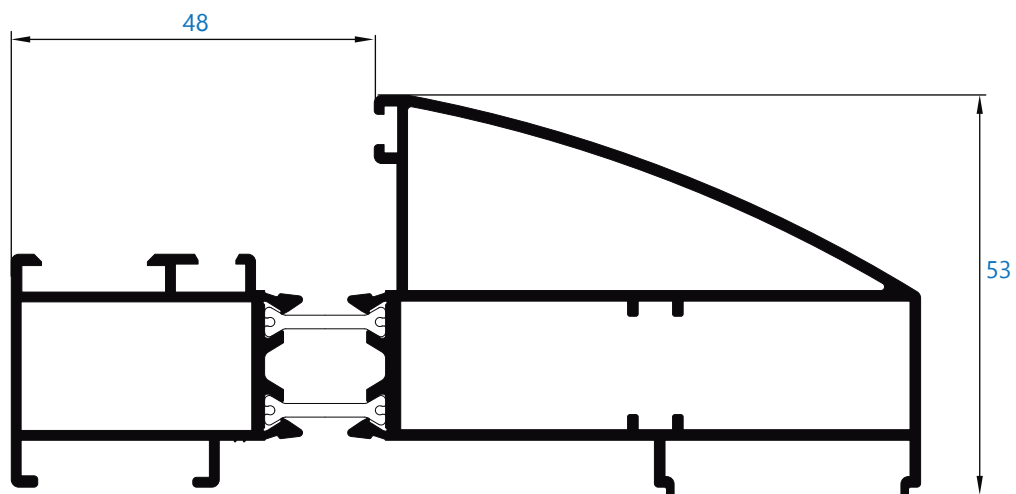

**R-133** paño fijo 3 carriles

Corredera Lineal Elevable

# Catálogo rotura

Alumial expertos en perfilaría de aluminio

**Corredera Lineal Elevable**

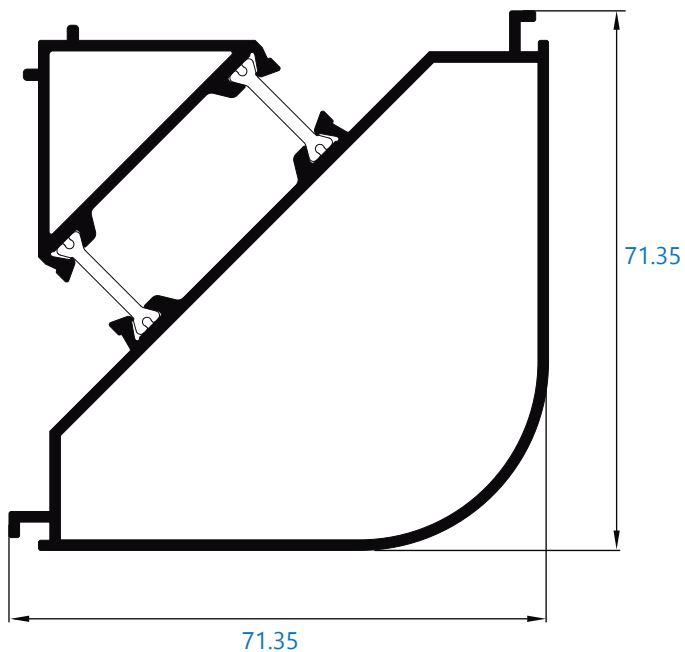

**R-141** esquinero fijo



**11265** tapa centros

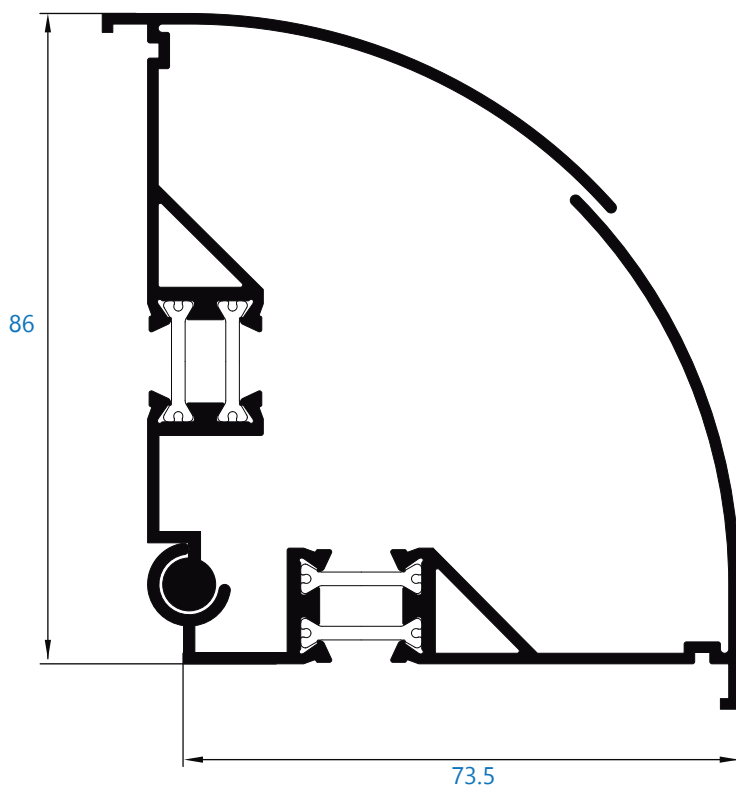

**R-142** esquinero regulable



**R-ERS "engatillado"** tapa centros



**R-URS "U"** marco

# Catálogo rotura

Alumial expertos en perfiles de aluminio

## Corredera Lineal Elevable

### TIPOS

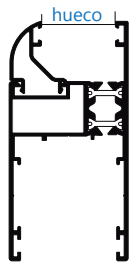









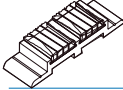





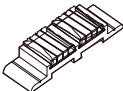







medida	retestar	grapa	nudo	liso	
4 mm					32 mm
11mm					25 mm
13 mm					23 mm
15 mm					21 mm
16 mm					20 mm
18 mm					18 mm
21 mm					15 mm
25mm					11 mm
28 mm					8 mm
29 mm					7 mm
33,5 mm					2.5 mm

# Catálogo rotura

Alumial expertos en perfilera de aluminio

## Corredera Lineal Elevable

KIT (cortav/ruedas/tapas/escuadra de alineamiento/tapeta/tope guía)			
referencia	descripción		
<b>RC8652D</b> <b>RC8652I</b>	kit corredera 2 hojas derecha KB-150 / 2 hojas izquierda KB-151		
 Cortavientos 2 unidades	 Rueda tandem regulable PT 4 unidades		
 Tapeta superior izquierda/derecha 2 unidades	 Tapa corredera izquierda/derecha 2 unidades		
 Escuadra 24 x 40 16 unidades	 Escuadra 6 x 21 8 unidades	 Tope guía 6 unidades	
referencia	descripción		
<b>RC8653</b>	kit corredera 3 hojas KB-152		
 Cortavientos 4 unidades	 Rueda tandem regulable PT 6 unidades		
 Tapeta superior derecha 4 unidades	 Tapa corredera derecha 4 unidades		
 Escuadra 24 x 40 24 unidades	 Escuadra 6 x 21 12 unidades	 Tope guía 10 unidades	
referencia	descripción		
<b>RC8654</b>	kit corredera 4 hojas KB-153		
 Cortavientos 4 unidades	 Rueda tandem regulable PT 8 unidades		
 Tapeta superior derecha 2 unidades	 Tapeta superior izquierda 2 unidades	 Tapa corredera derecha 2 unidades	 Tapa corredera izquierda 2 unidades
 Escuadra 24 x 40 32 unidades	 Escuadra 6 x 21 16 unidades	 Tope guía 14 unidades	



# Catálogo rotura

Alumial expertos en perfilaría de aluminio

## Accesorios Corredera Lineal Elevable

referencia	descripción
------------	-------------

**RC8651** kit elevable 2 hojas KB-149

 <p>Cortavientos 2 unidades</p>	
 <p>Tapeta superior derecha 2 unidades</p>	 <p>Tapa corredera derecha 2 unidades</p>
 <p>Escuadra 24 x 40 16 unidades</p>	 <p>Escuadra 6 x 21 8 unidades</p>

referencia	descripción
------------	-------------

**RC8655** kit elevable 4 hojas KB-154 **2 elevables + 2 correderas**

 <p>Cortavientos 4 unidades</p>		 <p>Rueda tandem regulable PT 4 unidades</p>	
 <p>Tapeta superior derecha 2 unidades</p>	 <p>Tapeta superior izquierda 2 unidades</p>	 <p>Tapa corredera derecha 2 unidades</p>	 <p>Tapa corredera izquierda 2 unidades</p>
 <p>Escuadra 24 x 40 32 unidades</p>	 <p>Escuadra 6 x 21 16 unidades</p>	 <p>Tope guía 12 unidades</p>	

referencia	descripción
------------	-------------

**RC8656** kit elevable+ corredera mixto 2 hojas KB-155 **1 elevable + 1 corredera**















 <p>Cortavientos 2 unidades</p>		 <p>Rueda tandem regulable PT 2 unidades</p>	
 <p>Tapeta superior derecha 2 unidades</p>	 <p>Tapa corredera izquierda 2 unidades</p>		
 <p>Escuadra 24 x 40 16 unidades</p>	 <p>Escuadra 6 x 21 8 unidades</p>	 <p>Tope guía 6 unidades</p>	

**ALUMIAL**

# Catálogo rotura

Alumial expertos en perfiles de aluminio

## Accesorios Corredera Lineal Elevable

<p>escuadra hoja/marco 1136F (250) <b>EX221002</b></p> 	<p>cartón base-kit carros HS200 7HS107300+EMBOLSADO <b>BA8701</b></p> 
<p>escuadra Monticelli para paño fijo 3 carriles elevable 0394 <b>BIE8107</b></p> 	<p>kit accesorios (calzos+cerraderos) 7HS200900 <b>BA8701K</b></p> 
<p>goma para corredera rotura 125.090 E1 (150) cuña-3N 1 R/C <b>RSG8473</b></p> 	<p>conjunto manilla ESURI interior c/uñero+Torn 50 7HSO381BL/7HSO381NE <b>BA8702LB/LN</b></p> 
<p>goma elevable 749.060 E1 (300) 1 R/C <b>RSG8658</b></p> 	<p>pletina unión carros 2 (HS-021) 7HSO21000 1601-1850(1337 mm) <b>BA8703.2</b></p> 
<p>cepillo para elevable-corredera RPT CS-7X11-4P BK (325) 2 R/C <b>TS8795N</b></p> 	<p>cierre Columba <b>BM8462</b></p> 
<p>rodillo para goma elevable <b>TA8140E</b></p> 	<p>juego cierre sin bloqueo "con muelle" 902-B/8(50) <b>MD8170DI</b></p> 
<p>falleba-cremonera 3HS BA-200 (1795-2295) 7HS051200 <b>BA8700</b></p> 	<p>juego cierre con seguro 902-B82(50) <b>MD8171DI</b></p> 











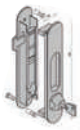

**ALUMIAL**

Polígono Industrial Goardia, 2 20213 Idiazabal Gipuzkoa Tel.: 943 18 73 04 Fax: 943 18 73 83

# Catálogo rotura

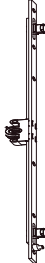
Alumial expertos en perfilaría de aluminio

## Accesorios Corredera Lineal Elevable

<p>cierre con llave F-91C <b>BM8662</b></p> 	<p>5982T40/4 medio cilindro 25*5 para multipunto LEVA larga 42 (6-10-26) <b>CVL8917</b></p> 
<p>tirador Lerma 11 para cierre Columba y Mendavia <b>BM8643</b></p> 	<p>5982/2525/4 cilindro 25*25 para multipunto LEVA larga 42 (26-10-26) <b>CVL8918</b></p> 
<p>juego tirador F-209 para cierre con llave F-91 <b>BM8671</b></p> 	<p>manilla interior ATLANTA 2917752/2934931 <b>PR8708LB/LN</b></p> 
<p>juego prolongador para multipunto con llave INFER/SUP 279205 <b>MA8680</b></p> 	<p>manilla SIRIUS acodada derecha/izquierda 07770/07780 (25) <b>ST8050D/I</b></p> 
<p>multipunto 1800 3 puntos entrada 15+3C-13+1SEG C-15 +5 soporte RC <b>BI864116RPT</b></p> 	<p>caja de embutir giro 90° entrada 40 mm para ATLANTA y SIRIUS <b>PR8314</b></p> 
<p>multipunto 600 entrada 15+ embolsado+calzos+ soporte RC <b>EX123640RPT</b></p> 	<p>multipunto con llave 100-1800+ 2 cerraderos MA8675+ 3 soporte RC <b>MA864114RPT</b></p> 
<p>multipunto 1000 entrada 15+ embolsado+calzos+ soporte RC <b>EX123641RPT</b></p> 	

**ALUMIAL**

# Catálogo rotura







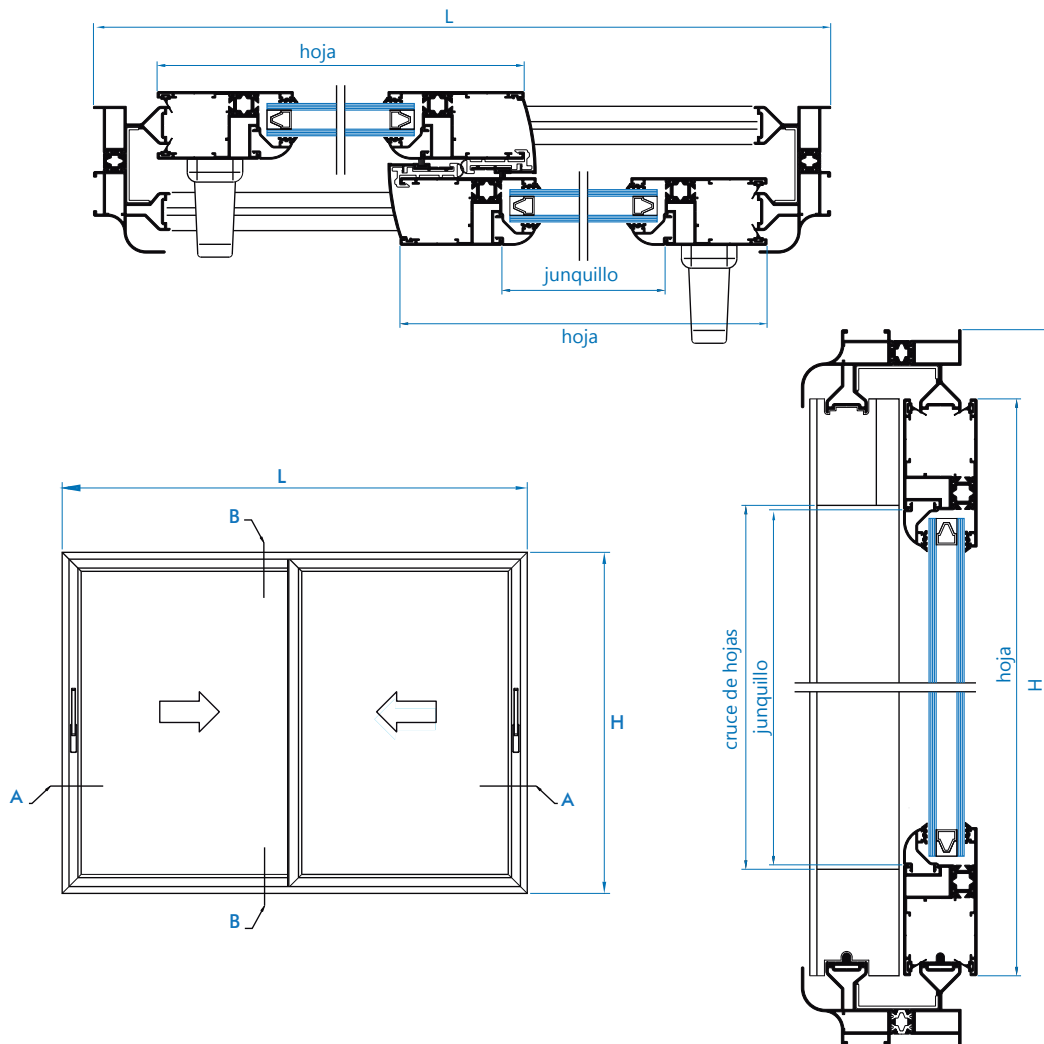

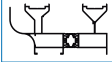

Alumial expertos en perfiles de aluminio

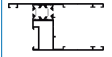
## Corredera Lineal Elevable

### Montaje ventana 2 hojas



Corredera Lineal Elevable

croquis	referencia	denominación	tipo de corte	cantidad	medida
	R-170	Marco perimetral		2 2	L H
	R-171	Hoja		4 4	L/2-1 H-78
	4796	Perfil guía		2	L-90
	11265	Tapa cruce de hojas		4	H-198
	032	Junquillo		4 4	L/2-126 H-203

# Catálogo rotura

Alumial expertos en perfiles de aluminio

## Corredera Lineal Elevable

### Montaje ventana 3 hojas

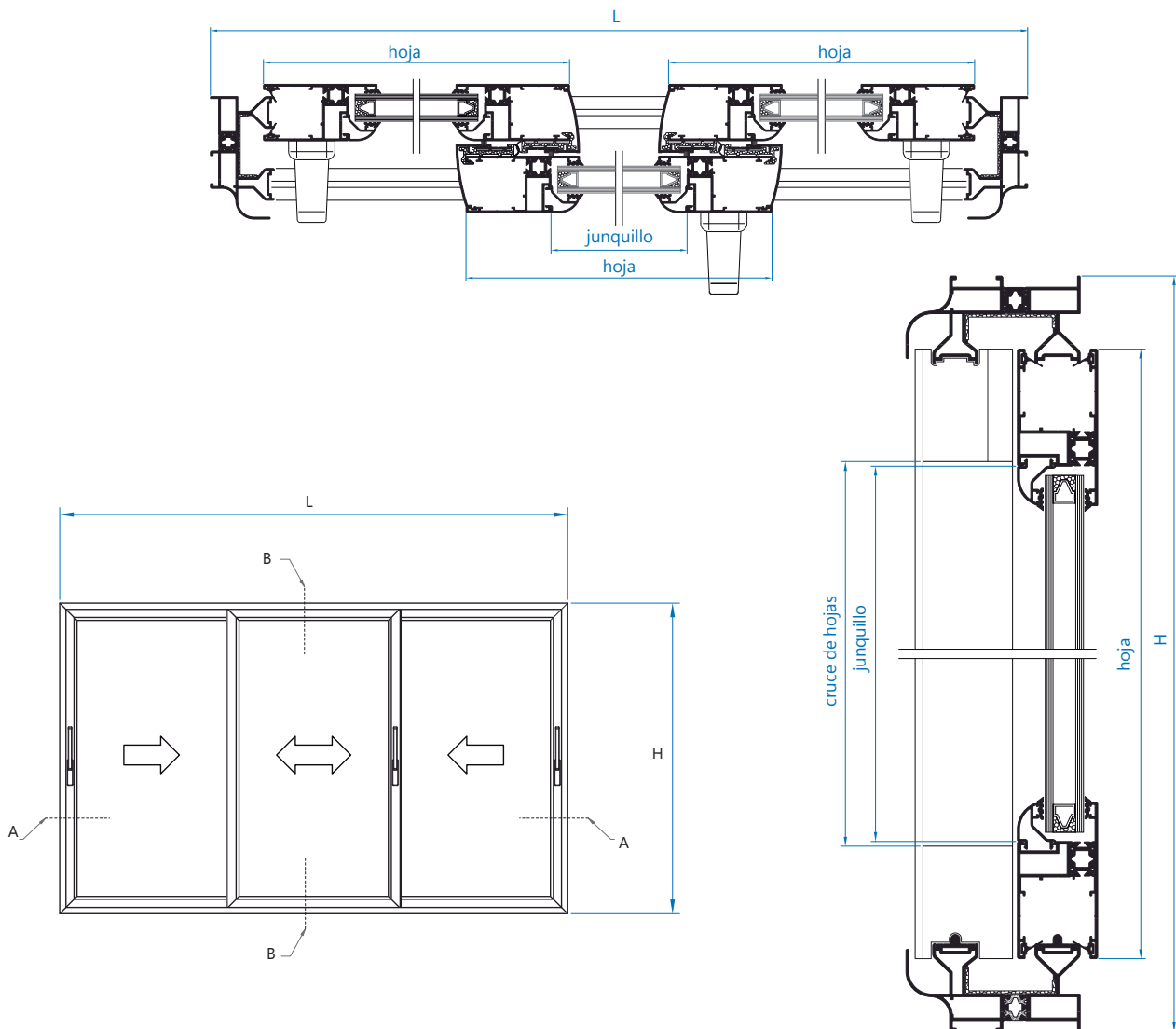

Corredera Lineal Elevable

croquis	referencia	denominación	tipo de corte	cantidad	medida
	R-170	marco perimetral		2 2	L H
	R-171	hoja		4 4	L/3+24.8 H-78
	4796	acople marco		2	L-90
	11265	tapa cruce de hojas		4	H-198
	032	junquillo		4 4	L/3+100.2 H-203

# Catálogo rotura

Alumial expertos en perfilaría de aluminio

## Corredera Lineal Elevable

### Montaje ventana 4 hojas

Corredera Lineal Elevable

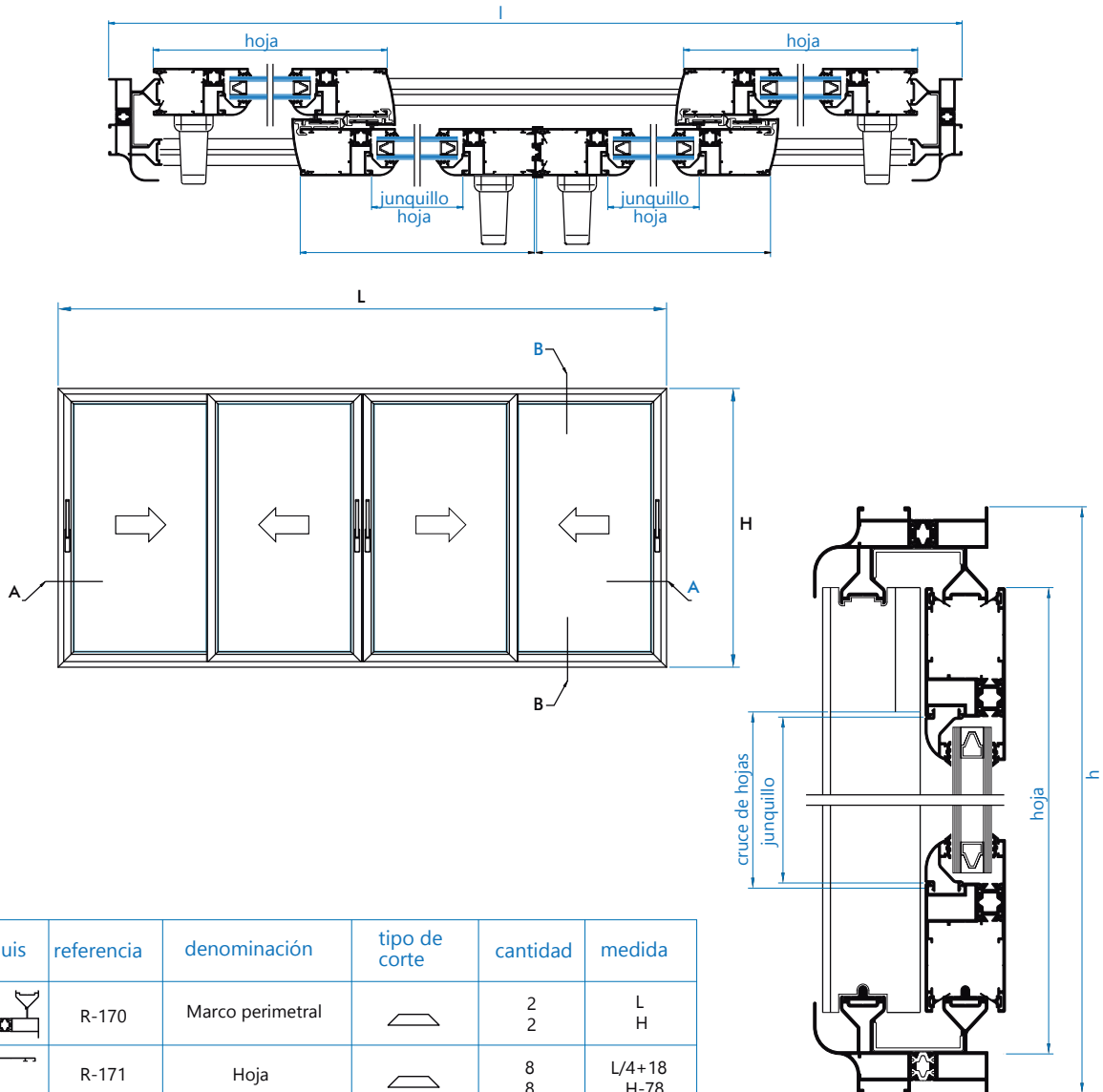

croquis	referencia	denominación	tipo de corte	cantidad	medida
	R-170	Marco perimetral		2 2	L H
	R-171	Hoja		8 8	L/4+18 H-78
	4796	Perfil guía		2	L-90
	11265	Tapa cruce de hojas		4	H-198
	R-135	Unión de hojas		1	H-78
	032	Junquillo		8 8	L/4+107 H-203