





Catálogo carpintería

Alumial expertos en perfiles de aluminio

Mallorquina Abisagrada

Características técnicas

Mallorquina Abisagrada+

-  **UNE-755-9:2009**
Medidas y tolerancias
-  **UNE-EN 573-3:2014**
Composición química
-  **UNE-EN 755-2:2014**
Características mecánicas
-  **UNE-38-350**
Aleación EN-AW-6060 T5
-  **UNE-38-337**
Aleación EN-AW-6063

ANODIZADO

Los tratamientos están garantizados por las marcas de calidad EURAS-EWAA, QUALANOD así como el certificado UNE-EN ISO 9001. El espesor mínimo obligatorio de la capa de óxido anódico es de 15 micras para el uso arquitectónico exterior, el cual se puede aumentar (20 o 25 micras), de acuerdo a los requisitos del cliente y leyes nacionales en el lugar de destino.

LACADO

El proceso de lacado utiliza pintura en polvo homologada por QUALICOAT. El espesor mínimo de la capa de lacado es de 60 micras para el uso arquitectónico exterior. El ciclo completo de lacado de los perfiles se realiza en pleno cumplimiento de la norma de calidad QUALICOAT.

Secciones	Marco 40 mm / hoja 47 mm	Aleación de extrusión	6060/6063 T5
Espesor perfilera	1,5 mm	Juntas	Medida de cepillo 5,5 x 6
Dimensiones máximas	2000 x 2300 mm para balconera de 2 hojas	Apertura	Posibilidad de bastidores fijos, abisagradas
Peso máximo hoja	120 kg/hoja		
Acabados	Lacado colores (RAL, moteados, rugosos...) Lacado imitación madera Anodizado		

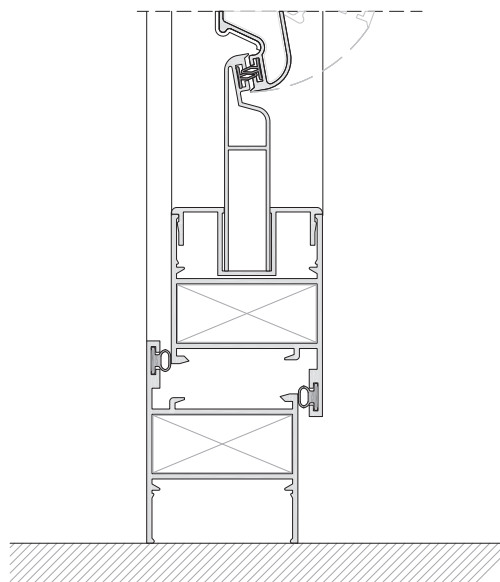

Catálogo carpintería

Alumial expertos en perfiles de aluminio

Mallorquina Abisagrada

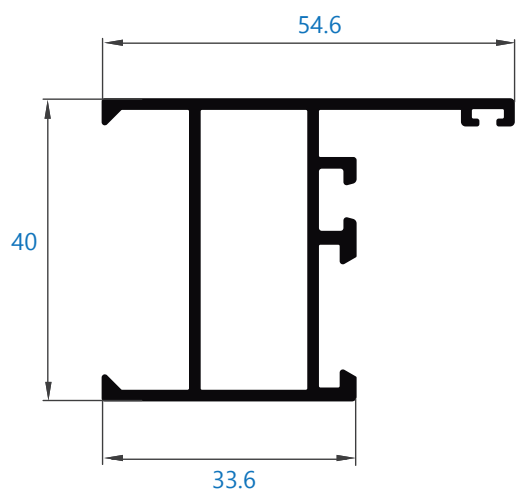

201 marco con orejas

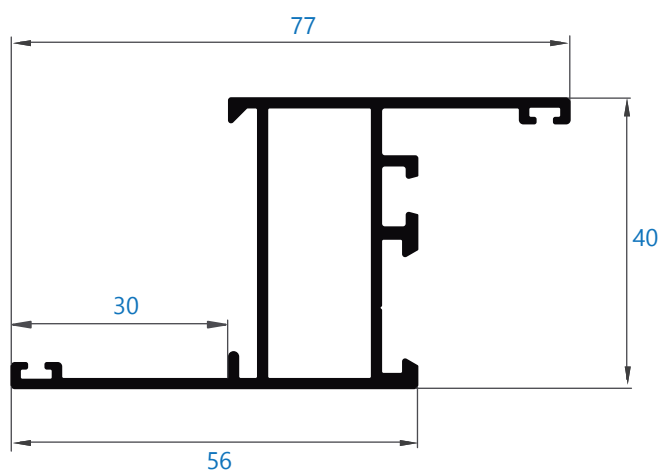

202 marco con solape

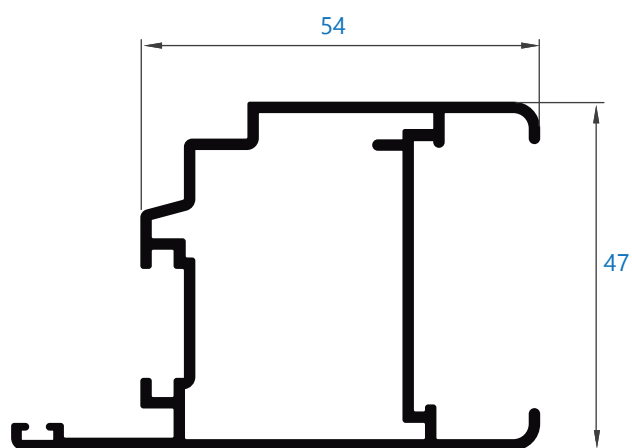

339 hoja mallorquina

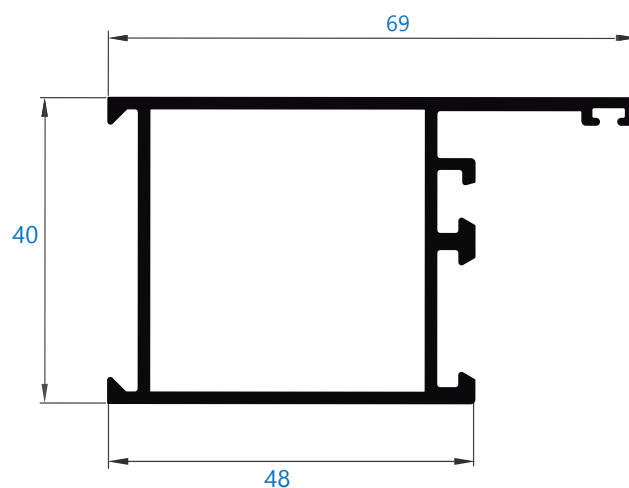

203 marco portada

Mallorquina Abisagrada

Catálogo carpintería

Alumial expertos en perfiles de aluminio

Mallorquina Abisagrada

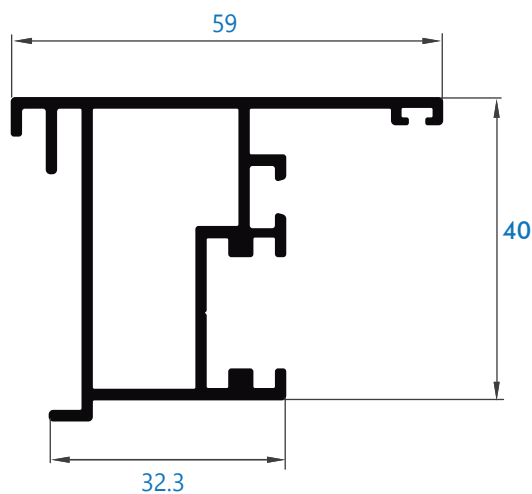

208 inversor central

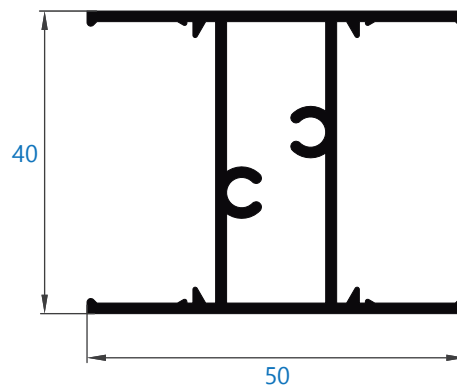

335 travesaño con gusanillo

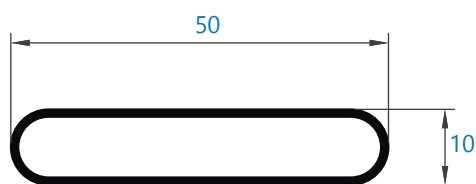

332 lama ovalada fija

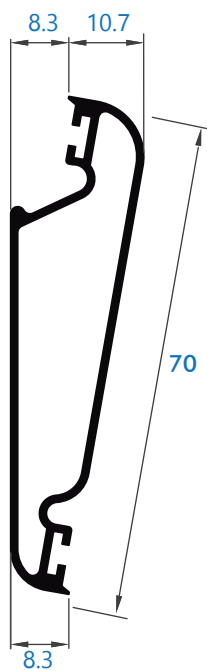

333 lama graduable

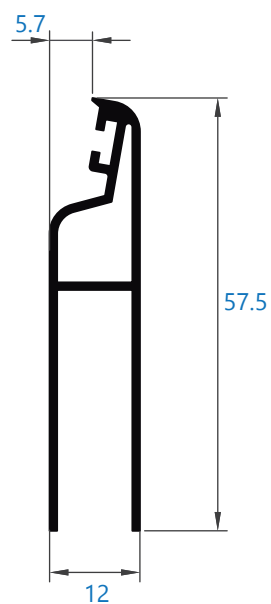

334 media lama graduable

ALUMIAL

Polígono Industrial Goardia, 2 20213 Idiazabal Gipuzkoa Tel.: 943 18 73 04 Fax: 943 18 73 83

Catálogo carpintería

Alumial expertos en perfilería de aluminio

Mallorquina Abisagrada

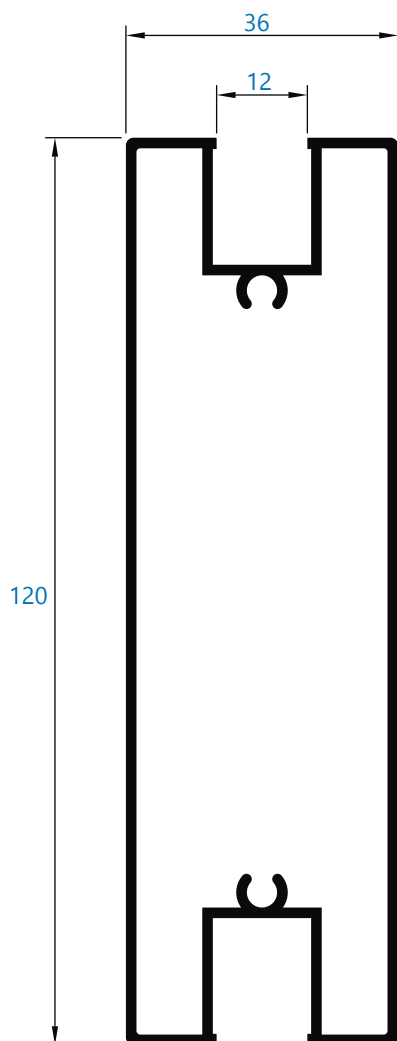

340 zócalo de mallorquina
*bajo pedido

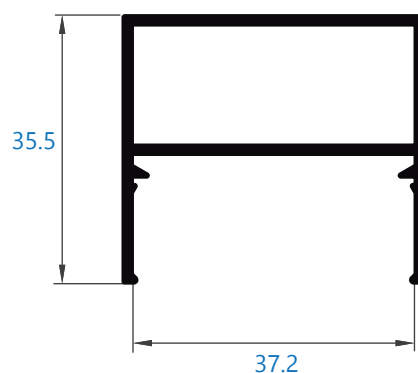

341 perfil mallorquina

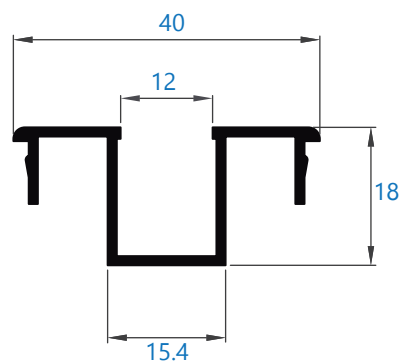

336 división de cristales

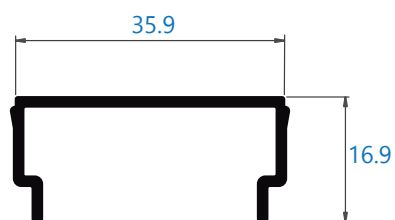

342 tapa de mecanismo

Mallorquina Abisagrada

Catálogo carpintería

Alumial expertos en perfiles de aluminio

Mallorquina Abisagrada

Mallorquina Abisagrada

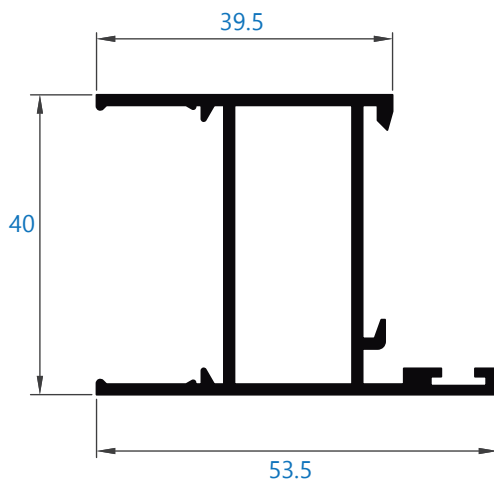

337 marco

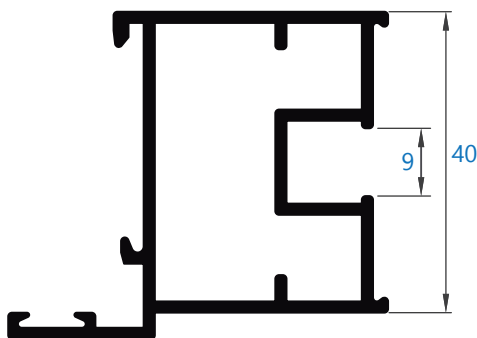

330 marco para lama fija

Catálogo carpintería

Alumial expertos en perfilaría de aluminio

Montaje ventana 1 hoja

Sección A-A

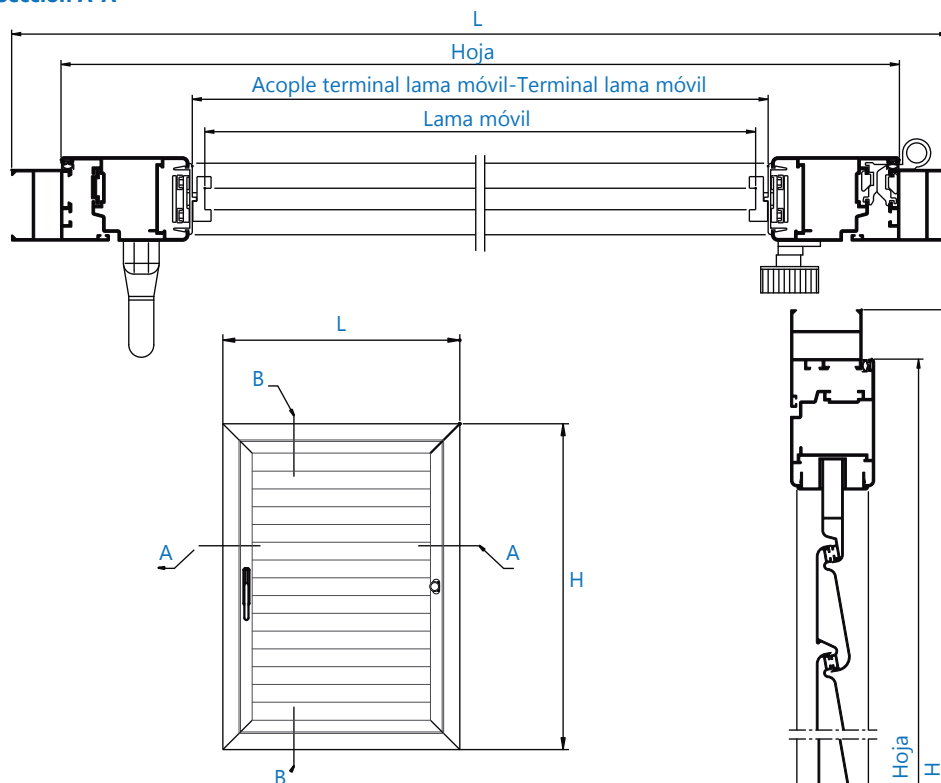

Sección B-B

croquis	referencia	denominación	tipo de corte	cantidad	medida
	201	marco		2 2	L H
	339	hoja mallorquina		2 2	L-55.2 H-55.2
	336	acople terminal lama		2	L-202
	334	terminal lama		2	L-202
	333	lama móvil		***	L-216
	015	pletina cremona		L	H

nº lamas	hoja mda. Luz alt./max.	nº lamas	hoja mda. Luz alt./max.	nº lamas	hoja mda. Luz alt./max.	nº lamas	hoja mda. Luz alt./max.	nº lamas	hoja mda. Luz alt./max.
3	282 mm	9	642 mm	15	1002 mm	21	1362 mm	27	1722 mm
4	342 mm	10	702 mm	16	1062 mm	22	1422 mm	28	1782 mm
5	402 mm	11	762 mm	17	1122 mm	23	1482 mm	29	1842 mm
6	462 mm	12	822 mm	18	1182 mm	24	1542 mm	30	1902 mm
7	522 mm	13	882 mm	19	1242 mm	25	1602 mm		
8	582 mm	14	942 mm	20	1302 mm	26	1662 mm		

ALUMIAL

Polígono Industrial Goardia, 2 20213 Idiazabal Gipuzkoa Tel.: 943 18 73 04 Fax: 943 18 73 83

Catálogo carpintería

Alumial expertos en perfiles de aluminio

Montaje ventana 2 hojas

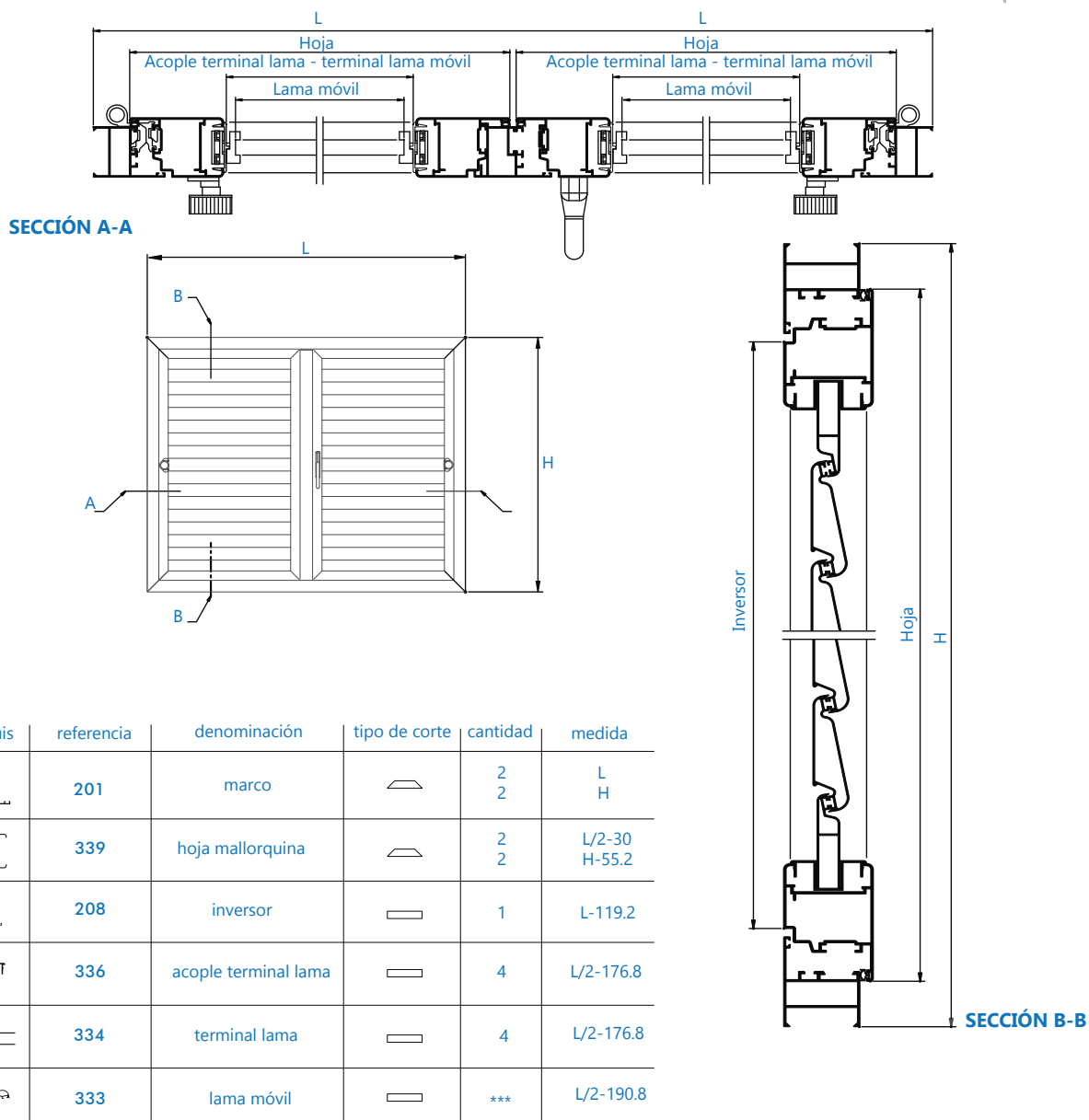

nº lamas	hoja mda. Luz alt./max.	nº lamas	hoja mda. Luz alt./max.	nº lamas	hoja mda. Luz alt./max.	nº lamas	hoja mda. Luz alt./max.	nº lamas	hoja mda. Luz alt./max.
3	282 mm	9	642 mm	15	1002 mm	21	1362 mm	27	1722 mm
4	342 mm	10	702 mm	16	1062 mm	22	1422 mm	28	1782 mm
5	402 mm	11	762 mm	17	1122 mm	23	1482 mm	29	1842 mm
6	462 mm	12	822 mm	18	1182 mm	24	1542 mm	30	1902 mm
7	522 mm	13	882 mm	19	1242 mm	25	1602 mm		
8	582 mm	14	942 mm	20	1302 mm	26	1662 mm		

ALUMIAL

Polígono Industrial Goardia, 2 20213 Idiazabal Gipuzkoa Tel.: 943 18 73 04 Fax: 943 18 73 83

Catálogo carpintería



Alumial expertos en perfiles de aluminio

Accesorios Mallorca Abisagrada





escuadras

referencia	descripción	color
ANE8398 	Escuadra hoja tiro largo 36-3928-150 (100)	S/C

goma y cepillo

referencia	descripción	color
RSG8152N 	Goma para lama 331.R050.03C1 (250) 4R/C	S/C
TS8259C 	Cepillo para lama graduable SP 5.5X6 3P (325) 4R/C	S/C

bisagra y manillas

referencia	descripción	color
ST8266 	Bisagra 3ª hoja pletina inox. 014D (30)	LB/LNM
ST8755D/I 	Bisagra 4ª hoja dcha./izqda. 2 palas 018D/018I (20)	LB/LNM
DP8268D/I 	Bisagra 4ª hoja dcha./izqda. pala larga 201(50)	LB/LNM
LV8670 	Manilla micro 30-480 (20)	LB/LNM

Catálogo carpintería

Alumial expertos en perfiles de aluminio



Accesorios Mallorca Abisagrada



referencia	descripción	color
LV8460D/I 	Cremona 4 hojas plana PR-8115 946DX/SX (10)	LB/LNM
LV8010 	Conjunto apertura exterior (2BULN(647) + 2 PROLOG. (487)+ 2 palas largas (486)) para manilla micro y plana	S/C
fijador hoja		
referencia	descripción	color
EX204030 	Mini grillo - seguro persianas (25) (2 piezas)	LNM
DP8263 	Mini grillo - sujeta ventanas (10) (1 pieza)	LNM
DP8257 	Grillo para 1 hoja de 44 a 64 mm (25)	LNM
DP8258 	Grillo "midi" para hoja de 85 a 101 mm (2 hojas) (20)	LNM
HE8490D/I 	Compás retenedor 90° y 80° drcha/izqda (3313/4450)	S/C

Catálogo carpintería

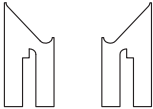
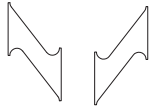
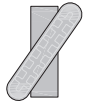
Alumial expertos en perfiles de aluminio

Accesorios Mallorca Abisagrada

accesorios lama		
referencia	descripción	color
DP8250D/I 	Terminal M-23 drcha./izqda. (50) lama fija Mallorca	LNM
DP8251 	Separador M-23/40 mm reversible (500)	LNM
DP8260 D/I 	Soporte drcho./izqdo. M-44 para marco lama fija 330 (500)	LNM
DP8261D/I 	Soporte drcho./izqdo. M-7 para división de cristales 336 (500)	LNM

mecanismo mallorquina		
referencia	descripción	color
IT8269 	Juego mecanismo G60 largo 3150 mm (se corta a medida)	LNM
IT8274 	Pomo c/transmisión ABS "C" 180°	LNM
IT8275DI 	Juego terminal 60 c/tornillo 09-008 DX-SX	LNM

Catálogo carpintería

Alumial expertos en perfiles de aluminio

Accesorios Mallorquina Abisagrada



referencia *bajo pedido	altura mínima de corte (mm)	altura standard	número de laminas	mando rotary A-mm
DP825506	400	460	6	264
DP825507	460	520	7	344
DP825508	520	580	8	404
DP825509	580	640	9	464
DP825510	640	700	10	524
DP825511	700	760	11	584
DP825512	760	820	12	344/644
DP825513	820	880	13	344/704
DP825514	880	940	14	344
DP825515	940	1000	15	344
DP825516	1000	1060	16	344
DP825517	1060	1120	17	344
DP825518	1120	1180	18	344
DP825519	1180	1240	19	344
DP825520	1240	1300	20	344
D9825521	1300	1360	21	344
DP825522	1360	1420	22	344
DP825523	1420	1480	23	344
DP825524	1480	1540	24	344
DP825525	1540	1600	25	344
D9825526	1600	1660	26	344
DP825527	1660	1720	27	344
DP825528	1720	1780	28	344
DP825529	1780	1840	29	344
DP825530	1840	1900	30	344

código	descripción
DP8255	Jgo. Mecanismo graduable
DP8256	Mando giro izqda/drcha

MECANISMO ITALNAC

código	descripción	altura	número de laminas
IT8269	Mecanismo mallorquina G60	3150	51
IT8274	Pomo transmisión ABS		

*se suministra a esta medida para cortar según se necesite.